



Digital DMR and Analog

DM-32UV

USER MANUAL

UHF/VHF Two Way Radio

THANK YOU!

Thank you very much for choosing our Dual Band Digital DMR and Analog two way radio.

This radio adopts the latest advances in technology, providing reliable communication in today's demanding communication environment.

This radio offers both DMR digital and analog communication, introduces innovative DMR digital processing system to achieve SMS, high-audio quality and digital encryption. It offers great stability, and reliability, together with long distance communication as well as fashionable design and compact exterior lines. Baofeng DM-32UV has Text Messaging, Record, Digital Encryption, Emergency Alarm, Work Alone GPS, APRS Location Reporting, Roaming, Analog DTMF, 2TONE, STONE, CTCSS/DCS encode/decode functions.

Notice to Users (FCC)

This device complies with Part 15 of the FCC rules per the following conditions:

- This device may not cause harmful interference.
- This device must accept any interference received, including interference that may cause undesired operation.
- Changes or modifications made to this device, not expressly approved by Baofeng, could void the authority of the user to operate this equipment.

Notice to Users (ISED)

The operation of your Baofeng radio is subject to the Radiocommunications Act and must comply with rules and regulations of the Federal Government's department of Innovation, Science, and Economic Development Canada (ISED). ISED requires that all operators using Private Land Mobile frequencies obtain a radio license before operating their equipment.

Notice to Users (RED)

European Users should note that operation of this unit in Transmit mode requires the operator to have a valid Amateur Radio License from their respective Countries Amateur Radio Licensing Authority for the Frequencies and Transmitter Power levels that this Radio transmits on. Failure to comply may be unlawful and liable for prosecution. At this subject, refer to the "EU" specification guide 2014/53/EU.

- » When programming the radio, start by reading the factory software data, and then rewrite this data with your frequency etc., to a new saved code plug, otherwise errors may occur.
- » You can use the programming cable with a PC to program the frequency, channel type, power etc. your programming must comply with your FCC , CE, UKCA, IC (or other country) license certification.

Safety Information Booklet

Preface

To help you ward off bodily injury or property loss that may arise from improper operation, please read all the information carefully before using our products.

Intended Use

Our products are designed to provide reliable wireless communication services for users across many industry sectors. In order to use the products safely and to achieve the best performance, they must be used as intended. The operator of the product is responsible for damage to the product or damage caused by the product if the product was used beyond the intended use instructions.

Intended use includes that:

- The product is used by users who have full knowledge of its RF exposure and can exercise control over their RF exposure to meet the occupational limits in FCC/ICNIRP and international standards.
- All the security instructions set forth in this document are always heeded.
- The general, national and in-house safety regulations are heeded.
- The product is exclusively used with the frequencies licensed by the respective authority.
- The product is configured appropriately by the dealer.

Besides, intended use also requires the product operator to be well-trained and to be familiar with the applicable standards, regulations and provisions.

RF Radiation Information

■ RF Radiation Profile

Radio Frequency (RF) is a frequency of electromagnetic radiation in the range at which radio signals are transmitted. RF technology is widely used in communication, medicine, food processing and other fields. It may generate radiation during use.

■ RF Radiation Safety

For function-related reasons, increased electromagnetic radiation may occur with specific products. Taking into consideration that unborn life is increasingly worthy of being protected, pregnant women should be protected through appropriate measures. People with personal medical devices such as cardiac pacemakers and hearing aids can also be endangered by electromagnetic radiation. The operator is obliged to assess workplaces with a considerable risk of exposure to radiation and to avert any hazards.

In order to ensure user health, experts from relevant industries including science, engineering, medicine and health work with international organizations to develop standards for safe exposure to RF radiation. Our product is designed and tested to comply with such standards, including:

- United States Federal Communications Commission. Code of Federal Regulations; 47CFR part 2 sub-part J.

- American National Standards Institute (ANSI)/Institute of Electrical and Electronic Engineers (IEEE) C95 .1-1992
- Institute of Electrical and Electronic Engineers(IEEE) C95. 1-1999
- International Commission on Non-ionizing Radiation Protection (ICNIRP)1998.

FCC Regulations

Federal Communication Commission (FCC) requires that all radio communication products should meet the requirements set forth in the above standards before they can be marketed in the U.S, and the manufacturer shall post a RF label on the product to inform users of operational instructions, so as to enhance their occupational health against exposure to RF energy.

EU Regulatory Conformance

As certified by the qualified laboratory, the product is in compliance with the essential requirements and other relevant provisions of the Directive 2014/53/EU. All applicable EU regulations are regarded (2006/66/EC , 2011/65/EU , 2012/19/EU).Please note that the above information is applicable to EU countries only.

Precautions for Portable Terminals

Operating Prohibitions

To protect you against any property loss, bodily injury or even death, be sure to observe the following safety instructions:

1. Do not operate the product in a location containing fuels, chemicals, explosive atmospheres and other flammable or explosive materials. In such location, only an approved Ex-protection model is allowed for use, but any attempt to assemble or disassemble it is strictly prohibited.
2. Do not operate the product near or in any blasting area.
3. Do not operate the product near any medical or electronic equipment that is vulnerable to RF signals.
4. Do not hold the product while driving.
5. Do not operate the product in any area where use of wireless communication equipment is completely prohibited.

■ Important Tips

To help you make better use of the product, be sure to observe the following instructions:

1. Do not use any unauthorized or damaged accessory.
2. Keep the product at least 2.5 centimeters away from your body during transmission.
3. Do not keep the product receiving at high volume for a long time.
4. For vehicles with an air bag, do not place the product in the area over the air bag or in the air bag deployment area.
5. Keep the product and its accessories out of reach of children and pets.
6. Please operate the product within the specified temperature range.
7. Continuous transmission for a long time may lead to heat accumulation within the product. In this case, please keep it at a proper location for

cooling.

8. Handle the product with care.

9. Do not disassemble, modify or repair the product and its accessories without authorization.

Precautions for Batteries

■ Charging Prohibitions

To protect you against any property loss, bodily injury or even death, be sure to observe the following safety instructions:

1. Do not charge or replace your battery in a location containing fuels, chemicals, explosive atmospheres and other flammable or explosive materials.
2. Do not charge your battery that is wet. Please dry it with a soft and clean cloth prior to charge.
3. Do not charge your battery suffering deformation, leakage and overheat.
4. Do not charge your battery with an unauthorized charger.
5. Do not charge your battery in a location where strong radiation is present.
6. Overcharge shall always be prohibited for it may shorten the life of your battery.

■ Maintenance Instructions

To help your battery work normally or prolong its life, be sure to observe the following instructions:

1. Accumulated dust on charging connector may affect normal charging. Please use a clean and dry cloth to wipe it on a regular basis.
2. It is recommended to charge the battery under 5°C~40°C. Violation of the said limit may cause battery life reduction or even battery leakage.
3. To charge a battery attached to the product, turn it off to ensure a full charge.
4. Do not remove the battery or unplug the power cord during charging to ensure a smooth charging process.
5. Do not dispose of the battery in fire.
6. Do not expose the battery to direct sunlight for a long time nor place it close to other heating sources.
7. Do not squeeze and penetrate the battery, nor remove its housing.

■ Transportation Instructions

1. Damaged batteries must not be transported.
2. To avoid short circuit, separate the battery from metal parts or from each other if two or more batteries are transported in one packaging.
3. The radio must be switched off and secured against switch-on, if the battery is attached.

The content of the shipment must be declared in the shipping documents and by a Battery Shipping Label on the packaging. Contact your hauler for the local regulations and further information.

Precautions for Disposal

Once the service life of our products (including but not limited to radios and batteries) has ended, they shall not be disposed as household garbage. Their recycling and disposal shall satisfy your local regulations.

Functional Features

-Digital-Analog compatibility, smooth transition

Supports both DMR digital and analog communication modes, ensuring smooth transition from the original analog products to digital products.

-TDMA dual time slot technology, doubling the user capacity

Straight-through dual-capacity mode communication, realizing two groups of calls at the same time in a frequency point, saving more frequency resources.

-UV Dual Band, Dual Watch, Aviation Band, NOAA weather band scanning reception

-Digital mode supports GPS/BeiDou Position, APRS, Roaming, Digital Record

-Digital call: All call, Group call, Private call, One-touch call.

-Additional features for Private call: Call Alert, Radio Check, Remote Monitor, Radio Disable, Radio Enable, Ranging.

-Message function. Support MOTOROLA, Hytera, DMR Alliance message format

-Voice and data security in digital mode, support customized, ARC4, AES128, AES256 digital encryption

-Digital alarm function, works alone

-AMBE+2™ voice encoder, clear and loud voice, no noise interference

-Analog mode frequency pairing, digital monitor, MR and VFO scanning

-Side key SK1/SK2/P1/P2 button function customization, does not change the user's operating habits of the radio

-Communication service types: Digital, Analog, Digital-Analog hybrid, Analog-Digital hybrid

-Scanner: Digital, Analog hybrid scanning, Frequency scanning, Channel scanning, scanning by frequency range, CTC/DCS scanning, scanning recovery mode selectable

-Analog features: Frequency Sweep, DTMF, 2Tone, 5Tone, BDC120 signaling and applications

-2.0" screen display, full keyboard input, channel switch and other professional grade industrial design.

1. Packing List

Unpack the radio carefully. We recommend that you identify the items listed in the following table before discarding the packing materials. If any items are missing or have been damaged during shipment, please contact the carrier or the dealer

Item	Quantity (PCS)	Item	Quantity (PCS)
Radio	1	Antenna	1
Battery	1	Radio Case	1
Charger	1	Instruction Manual	1
Power Adapter	1		

Check whether the frequency band on the antenna label matches that on the radio label. If not, please contact your dealer.

2. Component installation

2.1 Installing / Removing the Antenna

- Installing the Antenna: Screw the antenna into the connector on the top of the transceiver by holding the antenna at its base and turning it clockwise until secure.
- Removing the Antenna: Turn the antenna counter-clockwise to remove it.

2.2 Battery Installation and Removal

When installing, make sure the battery is aligned parallel to the radio body and the lower edge of the battery is about 1-2cm below the edge of the radio.

After aligning with the rails, slide the battery upward and lock the fastening screws.

Disassembly

To remove the battery, loosen the captive screws until the screws are free from the radio, and slide the battery downward until the battery is free from the body of the radio.

Before installing or removing the battery, make sure the radio is completely turned off by turning the power/volume knob counterclockwise.

2.3 Installing the Additional Speaker/Microphone (Optional)

Pry open the rubber MIC-Headset jack cover and then insert the Speaker /Microphone plug into the double jack.

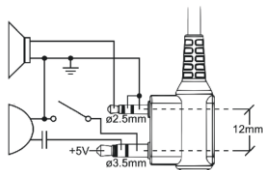

3. Charging and battery maintenance

3.1 Charging the Battery Pack

The Li-ion battery pack is not charged at the factory; please charge it before use.

Charging the battery pack for the first time after purchase or extended storage (more than 2 months) may not bring the battery pack to its normal maximum operating capacity. Best operation will require fully charging/discharging the battery two or three times before the operating capacity will reach its best performance. The battery pack life may be depleted when its operating time decreases even though it has been fully and correctly charged. If this is the case, replace the battery pack.

3.2 Charger Supplied

Please use the specified charger provided by Baofeng. Other models may cause explosion and personal injury. After installing the battery pack, and if the radio displays low battery with a red flashing lamp or voice prompt, please charge the battery.

3.3 Use Caution with the Li-ion Battery

- 1) Do not short the battery terminals or throw the battery into a fire. Never attempt to remove the casing from the battery pack, as Baofeng cannot be held responsible for any accident caused by modifying the battery.
- 2) The ambient temperature should be between 5°C-40°C (40°F - 105°F) while charging the battery. Charging outside this range may not fully charge the battery.
- 3) Please turn off the radio before inserting it into the charger. It may otherwise interfere with correct charging.
- 4) To avoid interfering with the charging cycle, please do not cut off the power or remove the battery during charging until the green light is on.
- 5) Do not recharge the battery pack if it is fully charged. This may shorten the life of the battery pack or damage the battery pack.
- 6) Do not charge the battery or the radio if it is damp. Dry it before charging to avoid damage.

WARNING:

» **When keys, ornamental chain or other electric metals contact the battery terminal, the battery may become damage or injure a human.**

If the battery terminals are short circuited it will generate a lot of heat.

Take care when carrying and using the battery. Remember to put the battery or radio into an insulated container. Do not put it into a metal container.

3.4 How to Charge

- 1) Plug the AC Adaptor into the AC outlet, and then plug the cable of the AC Adaptor into the DC jack located on the back of the charger. The indicator light blinks orange and is then ready to charge a battery.
- 2) Plug the battery or the radio into the charger. Make sure the battery terminals are good in contact with charging terminals. The indicator light turns to red--- charging begins.
- 3) It takes approximately 2-5 hours to fully charge the battery. When the lamp lights green, the charging is completed. Remove the battery or the radio unit with its battery from socket.

» **when charging a radio (with battery) the indicating lamp will not turn into green to show the fully charged status if the radio is powered on. Only when the radio is switched off will the lamp indicate normal operation. The radio consumes energy when it is power-on, and the charger cannot detect the correct battery voltage when the battery has been fully charged. So the charger will charge the battery in constant voltage mode and fail to indicate correctly when the battery has been fully charged.**

3.5 LED Indicator

STATUS	LED
No Battery	Green and red alternately flashing
Charge Normally	Red
Fully Charged	Green
Trouble	Red blinks fast for a long time

NOTE: Trouble means battery too warm, battery short-circuited or charger short-circuited.

3.6 Using the Type-C Charger

The Type-C charger is a handy port that allows you to conveniently charge your Li-ion battery pack.

1. Make sure your radio is turned OFF.
2. Plug the Type-C cable into the Type-C charging port on your battery. Connect the other end of the micro-USB charger to wall power outlet.
3. An empty battery will be fully charged in 4 hours.
4. The battery meter on LCD will move to indicate the battery is charging.

Note:

- *It is recommended to power OFF your radio while charging. However, if power is turned on while charging, you may not be able to transmit a message if the battery is completely empty. Allow time for the battery to charge to 1 bar before attempting to transmit a message.*
- *For optimal battery life, remove the radio from the charger within 6 hours. Do not store the radio while connected to the charger.*

3.7 Battery Maintenance

The radio is equipped with a lithium ion (Li-ion) rechargeable battery. The radio battery is not fully charged at the factory; allow it to charge for at least four to five hours before you begin using the radio.

- Use only batteries and chargers approved by the original manufacturer.
- Do not attempt to disassemble the battery pack.
- Do not short-circuit, catch fire or expose the battery to heat.
- Dispose of the battery in accordance with local recycling regulations. Do not dispose of the battery in the trash!

3.8 Extending Battery Life

- Charge the battery only at normal room temperature.
 - When charging the battery on the radio, turn off the radio to speed up charging.
 - Do not unplug the charger or remove the battery and/or radio until charging is complete.
 - Do not charge a wet battery.
 - The battery will drain over time. If you find that the operating time of your radio is greatly reduced, consider purchasing a new battery.
 - Below freezing temperatures reduce battery performance. Keep a spare battery for you when working in cold environments.
 - Dust can interfere with the contacts on the battery. If necessary, wipe the contacts with a clean cloth to ensure proper contact with the radio and charger.
- If the battery becomes wet, remove it from the radio, dry it with a towel, and place it in a plastic bag with a small amount of desiccant. Seal the bag and leave it overnight. The desiccant will absorb any moisture left in the battery. This method is only effective for light splashes (e.g., light rain). A soaked radio will most likely not be repairable.

3.9 How to Store the Battery

- a. If the battery needs to be stored, keep it in status of 80% discharged.
- b. It should be kept in low temperature and dry environment.
- c. Keep it away from hot places and direct sunlight.
 - » Do not short circuit the battery terminals.
 - » Never attempt to remove the casing from the battery pack.
 - » Never store the battery in unsafe surroundings, as a short may cause an explosion.
 - » Do not put the battery in a hot environment or throw it into a fire, as it may cause an explosion.

4. Radio Overview

You can use this section to familiarize yourself with the external structure, programmable key functions of the unit.

4.1 Product Illustration

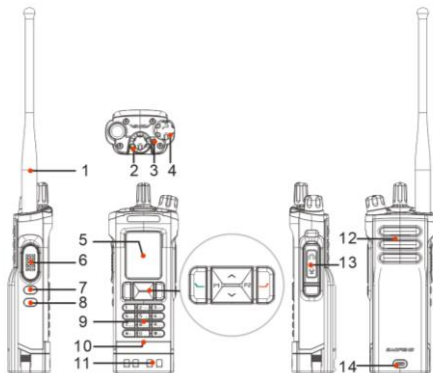



1. Antenna
2. Channel Switch
3. LED Status Indicator
4. POWER/VOL
5. 2" LCD

6. PTT Button
7. SK1-Customized SideKey
8. SK2-Customized SideKey
9. Numeric keys
10. MIC Input

11. Charge Contacts
12. Speaker
13. Speaker/Mic Jacks
14. Type-C charge port











4.2 Keys







[PTT] Transmit Key	Transmit and receive switch key, press this key and speak into the microphone when transmitting; when receiving, release this key.
SK1-Customized SideKey	Default short press is the radio function.
	Default long press for emergency alarm switch.
SK2-Customized SideKey	Default short press is the monitor function.
	Default long press is the power switch key.
P1-Customized function key	Default short press is [V/M] key to switch frequency/channel mode
	Default long press to toggle display mode: either display frequency, or display channel name, or display channel number
P2-Customized function key	Default short press is [A/B] screen (main/sub-frequency) key to toggle up/down screen
	Default long press for dual-frequency guard mode switching to toggle dual-guard dual standby, dual-segment single-guard, single-segment same-screen display
0-9 Numeric key	Default: 0 to 9
	Under DTMF function, it indicates [0 to 9] code characters.
	Under Pinyin Input Method, it indicates to select punctuation or letters.
	If set numeric shortcut function, long press this key to jump to the corresponding contact.
 Menu/Confirm key	Short press is used to activate the menu mode, after entering the menu, use this key to select each item in the menu.
	Long press this key and numeric key to enable one-touch function (valid after CPS setting)
 Back/Delete key	In menu mode, return to the previous menu or exit the menu.
	Long press this key to switch channel mode (MR) or frequency mode (VFO)
	Name or SMS editing input status, clear the inputted information.
 Up key	MR mode, change the channel upwards.

	SMS editing, move the cursor to the left.
【▼】 Down key	MR mode, change the channel downward.
	In SMS editing, move the cursor to the right.
【*】 key	Press and hold this key, the keypad locks the on/off function.
	Under DTMF function, indicates * code word.
【#】 key	Under the input method interface, switch the input method mode.
	In digital mode, short press to enter manual dialing, press # key to switch individual/group call. Analog mode to enter DTMF dialing

4.3 Status indication

A. LCD icon summary

Icon	Description	Icon	Description
	Digital Encryption On		Main band.
	Battery level indicator		There is/are unread short message(s).
	Positioned successfully		The InBox is full.
	Position turn on, but the position has not been successful.	V	VOX enabled
	The radio transmits and receives through a repeater		Double Slot turn on
+	Frequency shift direction if enabled in MR	H/M/L	TX power: -High Power/Low Power/Middle Power
-	Frequency shift direction if enabled in MR	DW	Dual Watch Activation
	Monitor is turned on	DCS	DCS enabled
	Record function is turned on	CT	CTCSS enabled

	The radio scanning		Scan stays on non-priority channels
VFO	Works in frequency mode	1--64	Memory channel
CH A	Under the call interface, TX or RX in A band	CH B	Under the call interface, TX or RX in B band
	The radio stays on priority channel 1.		The radio stays on priority channel 2.
	Digital mode, incoming call indication		Digital mode, call origination instructing
	Radio Silent turn on	N	Narrowband enabled (Analog mode)
DIG	Provides digital communication services	ANA	Provides analog communication services
D+A	Mixed digital, allows reception of both analog and digital signals, TX is digital	A+D	Mixed analog, allows reception of both analog and digital signals, TX is analog

When the battery level indicator reads  the battery is depleted. At this point the radio will start beeping periodically as well as flash the backlight of the display and when voice prompts are enabled, a "Low Voltage" announcement will be heard, indicating that you need to change your battery or put your radio in the charger.

Press the preprogrammed **[Battery Indicator]** Key to check the current battery voltage.

B. LED Indications

The top LED will help you to identify the current radio status.

LED Indicator	Radio Status
Glows red	Transmitting.
Glows green	Receiving.
Flashes orange slowly	Scanning

4.4 Programmed Key (SK1/SK2/P1/P2)

It is possible to set different functions for [SK1], [SK2], [P1], [P2] keys.

Method 1: In radio Menu - Settings - Radio Settings - Key Func - SK1, SK2, P1, P2 keys.

Method 2: In PC software – Public – Key Function.

Option	Functionality
None	No function is assigned to this button.
TX Power	To switch the power level between High/Middle/Low.
Battery Indicator	Check the current battery capacity voltage
Talk Around	To switch between Direct mode and Repeater mode.
Digital Encrypt	Choose the digital encryption group for digital channel
Call	In Analog mode, send the DTMF/STONE/2TONE encode. This function is only valid for analog channel.
VOX	To enable or disable the VOX feature.
VFO / MR	Switch between VFO mode and memory channel mode.
Alarm	Long press the key to start alarm, short press again to exit the alarm.
Hot Key 1~6	Selects Hot Keys 1-6. To make a call or send a message to the preset contact or implement an auxiliary feature.
Message	In digital mode, press to enter into SMS messages
Contacts	Directly access the contact list to quickly initiate calls or related services.
Zone Up	To switch to the previous zone.
Zone Down	To switch to the next zone.
Scan	To enable or disable the Scan feature.
Record Switch	Enable/disable the record function
Previous record	To playback the previous record.
Next record	To play back the next record.
FM Radio	FM radio on/off
FM Search	In radio mode, press this button to search for stations.
GPS Info	Check the GPS position information
Monitor	To enable or disable the Monitor feature.
A/B Switch	Choose channel A or channel B as the main channel
Work Alone	Turn on/off the work alone function.

Keypad Lock	To lock or unlock Keypad Auto Lock.
Nuisance Temporary Delete	To temporarily remove a currently unwanted channel from the scan list during scanning. The removed channel will not be scanned in subsequent scanning, but it will be restored into the scan list upon radio restart.
TBST Send	To send out a 1750Hz/1000Hz/1450Hz/2100Hz tone-burst.
APRS Send	Press this button to manually upload APRS information
Switch ChType	Switch the channel type(Analog, Digital, Ana+Dgi, Dgi+Ana)
Wait Mode	Single Mode/Double Wait/Single Wait switch
CTC/DCS Scan	Analog mode scan CTC/DCS
CTC/DCS Set	Analog mode setting CTC/DCS
Mute	Enable or disable all tones
Roaming	In standby, press the key programmed as "Roaming" to search and lock on the repeater with strongest signal. (Note: After lock on a repeater, the radio will return to last frequency only after channel or frequency is changed. The repeater frequency list must pre-programmed in CPS.)
Sub PTT	Press and hold this key to transmit on the B band (turn on the Dual PTT function and transmit on the B band)
Scramb	Analog mode, turn on or off the scrambl function
Freq Search	Analog mode, turn on or off the frequency sweep function
Flashlight	Flashlight on/off*
Man Down	To enable or disable the Man Down feature.

4.5 Shortcut Menu

Configure the shortcut menu for the radio through the CPS program software. The radio quickly enters the function  + number keys.

Option	Menu Select	Functionality
Call	Analog	Enables the One Touch Call function in analog mode.
	Digital	Enables the One Touch Call function in digital mode.
Menu	Message	Quick access to Messages in the menu
	New Message	Quick access to New Messages in the Menu - Messages
	Quick Text	Quick access to Quick Text in the Menu - Messages
	Inbox	Quick access to Inbox in the Menu - Messages

Outbox	Quick access to Outbox in the Menu - Messages
Contact list	Quick access to Contact list in the Menu - Contacts
Manual dial	Quick access to Manual Dial in the Menu - Contacts
Call Log	Quick access to Call Log in the Menu
Sent	Quick access to sent in the Menu - Call Log
Answered	Quick access to answered in the Menu - Call Log
Missed	Quick access to Missed Calls in the Menu - Call Log
Zone	Quick access to Zone in the Menu
Radio set	Quick access to Radio Set in the Menu – Settings

5. Basic Operations

5.1 Power on the Radio

Turn on the radio by turning the **[Power/Volume]** switch clockwise till a click is heard, and the LCD displays will show a start-up message, and you will hear a beep after three seconds.



Power off the radio

Turn the **[POWER/VOLUME]** switch counterclockwise to turn off the radio until you hear a “click” and the LCD screen will display “**Powering Down...**”.

5.2 Adjust Volume

Rotate the **[Power/Volume]** knob to adjust the volume. Turn clockwise to increase the volume and counterclockwise to decrease the volume. The LCD display will show the volume status during an adjustment.

5.3 Main Band/Sub Band Switch

Press the  key to switch the main channel to the other channel if there is 2 channels shown on the display. The band indicated by the  icon is the main band.

- ANA** is the analog format.
- DIG** is DMR digital.
- A+D** is mixed analog and DMR digital.
- D+A** is mixed DMR digital and analog.

5.4 VFO/Channel Switch

Press and hold the  key to switch between VFO and channel display.

- Frequency mode** will display the **VFO** symbol;

-**Channel mode** will display **CH XX** and the channel sequence.

5.5 Set Up VFO Frequency

Turn the radio to VFO mode, then press the  key to switch to the main band.

Operation 1: Press the  keys or turn the channel selector to adjust the VFO frequency steps.

Operation 2: Input the VFO frequency directly by the keyboard.

The following example assumes 12.5kHz frequency step. To enter a frequency of 432.5625 MHz on the main band.

(1) Press and hold the  key to switch to VFO mode.

(2) Enter [4][3][2][5][6][2][5] on the numeric keypad.



5.6. Select a zone



Zones make it easy to manage channels. A zone is a group of channels where multiple available channels are combined together.

Method 1: Press the pre-programmed [**Zone Up**] key or [**Zone Down**] key to select a zone.

Method 2: To select an area via the menu, perform the following procedure:

(1) Press the  key to enter Main Menu -> Zone.

(2) Press the  key to enter, then press the  key to select a zone.

(3) Press the  key to enter and then press  to select "**Apply**".

5.7 Select a Channel

Press and hold  key to switch the radio between VFO and Channel mode, select Channel mode.

Operation 1: Turn the channel switch to select a channel.

Operation 2: Input the channel numbers by the keyboard. For example, if you want switch to channel 64, input 0+6+4 a total of 3 digits, and it will switch to channel CH64.

A channel can either be Analog or Digital.

5.8. New channel (manually programmed channels)

Allows the creation of new channels. To create a new channel, proceed as follows:

(1) Press and hold the  key to switch to channel mode.

(2) Press the  key to enter Main Menu -> Setting -> Channel Set -> New Channel.

(3) Select **Analog**, **Digital**, **A+D**, **D+A** Channel Type.

(4) Enter the **channel alias** and confirm.

(5) Enter the **Rx frequency** and confirm.

(6) Enter the **Tx frequency** and confirm.

(7) Prompts "**Add success**" and returns to the previous menu.

Steps to add a new channel to a zone:

- (1) Press and hold the **Home** key to switch to channel mode.
- (2) Press the **Menu** key to enter Main Menu -> Zone -> Select a zone and confirm.
- (3) Press **▲/▼** key to select “**Add Channel**” .
- (4) Press **▲/▼** key to select the channel you just added in the channel list and confirm.
- (5) Prompt “**Add Success**” and return to the previous menu.

To configure parameters for a newly created channel:

- (1) Long press the key to switch to channel mode.
 - (2) Press the key to enter Main Menu -> Settings -> Channel Set.
- Analog channel can configure parameters such as CTCSS/DCS, alias, channel bandwidth and so on.
 - Digital channel can be configured with parameters such as TX Contact, RX Group List, Color Code, Time Slot, Radio ID, Alias and so on.

5.9. Calling services

5.9.1 Digital Calls

You can originate or receive the following types of calls on a digital channel:

- **Private Call**: a call from a single user to another single user.
- **Group call**: a call from a single user in a group to all other members of the group.
- **All Call**: a call from a single user to all other users on the current channel.

You can ask your dealer to enable the All Call feature.

5.9.2 Making a Call

You can making a call by the following operation methods.

- Turn the channel switch to choose a programmed channel. press and hold the [PTT] key to make a call directly to a pre-programmed contact on the current digital channel.
- Select “**Contacts List**” in the “Talk Group” menu, select one of the contacts, and then press and hold the [PTT] key to make the call.
- Select “**Call Log**” in the main menu, enter the **Missed / Answered / Sent** call list, select a call log, and then press and hold the [PTT] key to make the call.
- Select “**Talk Group > Manual Dial**” in the main menu, press [#] key to switch between private call number or group call number, enter the number and press and hold the [PTT] key to make the private call or group call.
- When the dealer configures the call object of [Call] as a personal call contact or group call contact, press the



pre-programmed [Call] key and then press and hold down the [PTT] key to make a personal call or group call.

Hold the radio vertical 2.5-5cm from your mouth, press the [PTT] key to start the call, the red LED lights up, the receiver ID/ name/ city/ state/ country/ call type and call out icon will be display on the LCD.

Release [PTT] key to receive the reply.

If you set the channel transmit power to “Low” and cannot make a successful call, you can use the pre-programmed [TX Power] key to temporarily switch to high power transmission.

5.9.3 Receiving and Replying to Calls

When the radio is in digital mode, it can receive and respond to calls with the same frequency/color code/time slot. When receiving a call:

- (1) If the caller DMR ID number is a programmed ID number in the receiver's digital contact list, the radio will ring briefly when answering a call.
- (2) The LCD screen will display the corresponding DMR ID/alias/city/state/country/call type and inbound icon based on the contents of the contact list.
- (3) The green LED lights up.
- (4) You can reply by press and hold the [PTT] key after the other party has finished the call.

5.9.4 Ending a Call

- **Private Call /group call:** When no one on both sides presses the [PTT] key to speak and exceeds the call hold time, the terminal will end the call.

-**All Call:** The terminal will end the all call when the caller releases the [PTT] key.

5.10 Monitor

In standby, press the pre-programmed [Monitor] key to enter Monitor. When receiving matched carrier but the signaling / ID is unmatched or the signal is too weak, this function allows monitor the weak signal and signal with unmatched ID.

Press the pre-programmed [Monitor] key again to shut off speaker and return to standby.

» When in analog mode, if no signal, it will emit noise when press the [Monitor] Key.

** The  icon is seen when monitor is activated.

5.11 Emergency Alarm

The emergency alarm function can only be triggered by press the [Alarm] key when the channel is configured with an alarm system. The following alarm types can be programmed by the CPS:

-**None:** the alarm function cannot be used.

-**Siren only:** Alarm tone is given locally and the control center will not receive the alarm signal.

-**Normal:** in alarm state, with sound and visual indication.

-**Secret:** in alarm state, without any sound and visual indication.

-**Secret with voice:** in the alarm state, without any sound and visualization indication, except for the sound that will be released if a call is received.

-**Alarm siren:** a local alarm tone is emitted after sending an emergency alarm signal to the control center. In the alarm state, there are audible and visual indications.

Press pre-programmed [**Alarm**] key to turn on emergency alarm function, then press this key again to return.

5.12 Work Alone

If an unforeseen situation is encountered during a solo job and the radio cannot be operated within the pre-programmed time, the radio will automatically alert and inform a companion or the control center for assistance.

Press the pre-programmed [**Work Alone**] key to turn on work alone.

Response time (1-256 minutes), reminder time (1-256 seconds), operating mode, and tone selection for work alone can be set through the CPS programming software.

CPS Setting Path: Public-Optional Functions- work alone.

5.13 Man Down Alarm

The radio is equipped with Man Down function. After this function is activated, if the radio is not corrected within the “Man Down Delay Time” time after it is tilted to a certain angle, or if it continues to be in a stationary state during the “Man Down Delay Time” time, the radio will send an alarm status message to the alarm number. The radio will send the alarm status message to the alarm number.

Moving or righting the terminal exits the emergency alarm.

Press the pre-programmed [**Man Down**] key to turn on the Man Down function.

The Man Down delay time can be set through the CPS programming software.

5.14 FM Radio functions

Turn on or off the radio as follows:



Press the  key to enter the main menu -> Settings -> Radio Settings -> Key Function -> Customize any one of the “SK1/SK2/P1/P2” keys as [**FM Radio**].

Turn the radio on or off by press the pre-programmed [**FM Radio**] key.

After turning on the radio function, the radio station search method is as follows:

(1) Press the  key to switch the radio band between 65-76M or 76-108M respectively.

(2) Press the [**#**] key to enter the radio station search mode, the screen displays 'Seek...'.
-Press / key to select the radio channel according to the preset step frequency.

-Press / key to select the radio channel according to the preset step frequency.

-Directly input the familiar radio station frequency through the numeric keys (frequency mode, e.g. 96.9MHz, input 0969)

-Short press the preset [**FM Radio**] function key or key to exit the radio mode.

5.15 Battery Voltage Test

Press the programmed [**Batt Indicator**] key to check the current battery level, which will be accompanied by a voice prompt “Battery High / Battery Medium / Battery Low”.

5.16 One Key Sweep

In analog mode, press the **☰** key to enter Main Menu -> Settings -> Radio Settings -> Key Function -> Customize any one of the “SK1/SK2/P1/P2” keys to [**Freq Search**].

When using the **Freq Search** function, the radio will act as a scanning receiver.

Turn on the radio, press the pre-programmed [**Freq Search**] key to enter the frequency sweep mode, and the screen will display “Seek...”.

Successful sweeping will display the resolved frequency and CTCSS/DCS, and turn on the speaker.

You can press the **☰** key to save the swept frequency and CTCSS/DCS to the channel.

Press and hold the [PTT] key to making a callback.

5.17 Keypad locking and unlocking

The radio has the ability to lock the keypad, there are two locking modes: manual mode and automatic mode.

-**Manual**: Press the pre-programmed [Keypad Lock] key to lock the keypad.

-**Auto**: To allow the keypad to lock automatically, follow the procedure below to enable the “Keypad Lock” feature:

(1) Press the **☰** key to enter the Main Menu -> Settings -> Radio Settings -> Key Functions -> Key Lock -> Switch.

(2) Select “**Delay Time**”, then press **▲/▼** key to set the delay time.

-Keypad Unlock: Press the **☰** key, then press * to unlock the keypad.

5.18 Keyboard Input

You can input user alias, number, SMS, etc. through the keypad of this unit. This unit supports English input method, Pinyin input method, and numeric input method.

-To switch the input method between alphabet mode and numeric mode, press [**#**].

-To enter special characters, press [**1**] in alphabet mode or numeric mode.

-To enter a space, press [**0**] in letter mode.

Note: During input, if there is no content in the editing area, press the key to return to the previous menu; if there is content in the editing area, press the key to delete a character before the cursor until there is no content in the editing area, then press the key to return to the previous menu. In the input text display area, press **▲/▼** to move the cursor left/right.

5.19 Dual Watch

-**Single Mode**: Single band mode, only the channel name, frequency, channel number, and area where the working band is located are

displayed.







-**Double Wait:** The screen displays the **DW** icon. The same screen displays the main frequency and sub-frequency, and guards calls from the main frequency or sub-frequency. The factory default is Dual Band Dual Watch mode.

-**Single Wait:** No **DW** icon is displayed on the screen. The screen displays the primary and secondary frequencies on the same screen, but only receives calls from the primary band, then the secondary band will be prohibited from receive calls.



6. Advanced Features

6.1 Access Advanced Features for Private Call

Method 1: Access Private Call from Contacts List

- (1) Press  key to enter **Talk Group /Contacts list**, press  key to select a Private Call contact.
- (2) Press  to confirm to enter View Contacts, press  to confirm to view contact information.
- (3) Press  key to select application function.
- (4) Press  to confirm to enter the application function.

Method 2: Access by manual dial

- (1) Press  key to enter **Talk Group**, press  key to enter Manual Dial.
- (2) Press  Confirm to enter Manual Dial and enter the caller ID.
- (3) Press Option to enter the application function.

Method 3: Press # key CSV Contacts access

- (1) Press # key to enter CSV contacts.
- (2) Enter the Private Call ID and press Option to enter the application function.

6.2 Set Up Application Features for Private Call

(1) Radio Check

Select **Radio Check**, and it will send out a radio check to the target radio which will send back a message if it is available or not available to the transmit radio. With this feature, you can determine if another radio is active and powered on in the system.

(2) Call Alert

Select **Call Alert**, it will send out a call alert, the target radio will sound a beep or vibrate when receiving the call alert, and it will return a success call or failed call message to the transmit radio.

(3) Remote Monitor

Select **Remote mon.** and it will send out a signal for the target radio will turn on its microphone and transmit when receiving the signaling, it will send back the voice to the transmit radio. With this feature you can monitor the sound activity near the target radio remotely.

(5) Radio Disable

Select **Radio Disable**, and it will send out a disable signaling to the target radio which will be disabled (No display, no operation) when receiving the signaling and it will send back a disable successful message to the transmit radio.

(6) Radio Enable

Select **Radio Enable**, and it will send out a enable signaling to the disabled radio and the target radio will return to standby when it receives this signaling and send back a enable successful message to the transmit radio.

(7) Measure Period

When caller and receiver both GPS positioned, if the caller turn on measure period function and the receiver is within communication range, Tx radio will detect the distance and direction between two radios at fixed interval, and then show the information on the display of Tx radio.

7. Main menu functions

The unit's menu has an automatic reset function, if you do not perform any operation on the menu within the pre-programmed time (configured by your dealer), the product will automatically return to the standby interface. You can modify the menu reset time through your dealer.

-No Zone main menu in DMR and VFO mode.

-Analog and VFO mode, only Scan and Settings main menu.





-In DMR and MR modes, there is no CTCSS/DCS and step frequency submenu, and there is no menu and submenu for analog attributes.

-In analog and MR modes, Scan, Zone, Settings main menu only, no menus and submenus for DMR function attributes.

-GPS system are optional and must be supported by hardware.





When this document describes the menu operation, it only describes the order of the menu items. For example, the path to the Contacts List is "Talk Group -> Contacts List".

Basic menu operation

1. Press the  key to enter the main menu.
2. Use the / keys to navigate to your desired submenu or option.
3. With a given sub-menu or option parameter selected, you have two choices:
 - A. Press the  key to save your settings and return to the previous menu.
 - B. Press the  key to reset the menu item and return to the previous menu level.
4. To exit the menu at any time, press the [PTT] key.

Menu Quick Use

Menu items are accessed quickly by press and hold the  key in combination with a sequence of numbers.

1. Press the  key to enter the first level menu.
2. Use the numeric keypad to enter the number of the menu item.
3. Press the  key to enter the secondary menu (also known as the “submenu”).
4. Use the numeric keypad to enter the number of the menu item to quickly select the desired menu item.
5. Select the parameter to be set for the given menu item;
 - (1) Press the  key to save your settings and return to the main menu.
 - (2) Press the  key to reset the menu item and allow you to exit the menu completely.
6. Press the  key to return to the previous menu level. Press the [PTT] key to quickly exit the menu.

7.1 Talk Group

Contact List: Will display the talk group list which had been programmed in the PC software. This list is used as a look-up table to display the contact talk group information when receiving a call.

New Contact: Allows to create a new talk group.

Manual Dial: Input the group ID or private ID to access a talk group quickly.

CSV Contacts: will display DMR contacts that have been programmed in the PC software, detailing the contact's Alias, DMR ID, repeater number, City, State, Country, and Remarks. This list is used as a look-up table to display the contact talk group information when receive a call.

Talker Alias: Allows Alias Tx Set / Alias Rx Set.

7.2 Scan

In the PC software – Public – Scan list, it allows to save 32 scan lists, and to program the required scan lists and write it into radio. Switch the radio to channel mode, as the scan list is only valid in the channel mode.

7.2.1 Turn On Scan

Method 1: Press the pre-programmed [**Scan**] key to turn on the scan function.

Method 2: A channel has enabled the “Auto Scan” function and configured the scan list, when switch to this channel, the radio will automatically turn on the scan.

Method 3: Press the  key to enter the main menu -> Scan -> Scan switch to turn on the scan function.

Turn off Scan

Method 1: In the scanning state, press the [**Scan**] button to exit.

Method 2: Turn off scanning through the “Scan” menu.

Method 3: Channel auto scanning is on, just switch the channel.

7.2.2 Scan List Operation

(1) Press  (Menu) to enter the main Menu -> Scan -> Scan List.

(2) Select a scan list and press **≡** to enter scan list submenu. Make the following settings:

-**Apply**: Enable the current scan list.

-**Edit/View List**: Edit the current list, you can add or delete scan channels for the current list, set the priority scanning channels.

>>Cur Chan: -Edit Priority Channel. Edit Priority Channel 1, Priority Channel 2, Disable Priority Channel.

>>Display add channels (members of scan list)

>>Add Chan: Allows to continue add channels to this list, jump to the channel list (available channels).

-**Edit Name**: allows to reset the list name.

-Set Priority Channel

You can set the currently selected channel as a priority or non-priority channel. If you need to focus on activity on a particular channel, you can set it as a priority channel. Priority channels are scanned more frequently than non-priority channels. A maximum of two priority channels can be set in each scan list; P1 for priority channel 1 and P2 for priority channel 2.

-To delete a channel from the scan list

Select "**Delete**" to remove it from the scan list. However, you cannot delete the first channel in the scan list.

7.2.3 VFO Scan Range

In frequency mode, you can set the VFO scan range, scan recovery method, and step frequency.

VFO scan range, i.e. the frequency to start scan and end scan.

(1) Press the **≡** key to enter Main Menu -> Scan -> VFO ScanRange (V)

(2) Press the **≡** key to enter the VHF band scan range setting.

(3) Through the numeric keypad, input the scan range, such as scan range 144-146MHz, input [1][4][4][1][4][6].

-Set the scan range for the UHF band in the same way.

7.2.4 VFO Scan Modes

The following scan recovery methods are supported in frequency mode:

-TO (Time Scan): The scan will stop when a signal is detected and it will resume scan after 5s of staying in the channel.

-CO (Carrier Scan): Scanning will stop when a signal is detected until the signal disappears, and it will resume scanning 2s after the signal disappears.

-SE (Search Scan): The scan will stop when a signal is detected and it will terminate the scan.

7.2.5 Scan CTCSS

Scan CTCSS in the case of known frequencies.

(1) Press the **≡** key to enter Main Menu >> Scan >> Scan CTCSS.

(2) Press the **≡** key to start CTCSS scan. A valid CTCSS code is scanned and the horn turns on.

7.2.6 Scan DCS

Scan for DCS in a known frequency situation.

(1) Press the **≡** key to enter Main Menu >> Scan >> Scan DCS.

(2) Press the **≡** key to start DCS scan. A valid DCS code is scanned and the horn turns on.

7.2.7 Scan CTCSS/DCS Memory

In Channel Mode or Frequency Mode, scanned CTCSS/DCS can be memory as TX CTCSS/DCS Only, RX CTCSS/DCS Only, and TX& RX CTCSS/DCS to replace the calls current Channel or Frequency Mode CTCSS/DCS setting.

The CTCSS/DCS scan memory setting is operated as follows:

(1) Press the **≡** key to enter Main Menu>>Scan>>Scan Memory.

(2) Press the **≡** key to enter the CTCSS/DCS scan memory setting, and press **▲/▼** to select:

- **TX CTCSS/DCS**: The scanned CTCSS/DCS will be stored as the transmit CTCSS/DCS of the current channel or frequency mode (replacing its TX-CTC/DCS only).

- **RX CTCSS/DCS**: The scanned CTCSS/DCS will be memory as the receive CTCSS/DCS for the current channel or frequency mode (replacing only its RX-CTC/DCS).

- **All**: The scanned CTCSS/DCS will be memory as both the TX and RX CTCSS/DCS of the current channel or frequency mode (as both the TX **and** RX CTCSS/DCS).

(3) Press the **≡** key to save the setting and return to the previous menu level;

NOTE: Only when a valid CTCSS/DCS is scanned and stays, press the key to memory the CTCSS/DCS and replace the corresponding CTCSS/DCS for the current channel or frequency.

7.2.8 Frequency Scan

Press and hold the **🏠** key to switch to VFO mode and enter the frequency via the numeric keypad. Press the pre-programmed **[Scan]** key to turn on the scan function. Or operate through the menu function as follows:

(1) Press the **≡** key to enter the main menu -> Scan -> Scan switch to turn on the scan function.

(2) You can operate as follows during scanning:

-Press **▲** key to scan in preset step frequency increments.

-Press **▼** to scan in preset step frequency increments.

-Scanning to a frequency with activity, the terminal will stay on the active frequency until the activity disappears. While scanning stays, press and hold the **[PTT]** key, the LED indicator lights up red, and then speak into the microphone. Release the **[PTT]** key to answer.

(3) Scanning status, press the pre-programmed **[Scan]** key to exit scan.

-Or turn off scan through the “Scan” menu.

7.3 Zone

7.3.1 Select a Zone

A Zone is a group of channels grouped together. The DM-32UV DMR radio has 250 Zones. A Zone can have the maximum of 64 analog and/or digital channels.

Method 1: Press the pre-programmed **[Zone Up]** or **[Zone Down]** key, press ▲/▼ to select a zone from the zones list and the LCD screen will display the selected zone number or name.

Method 2: Menu operation is as follows

(1) Press the  key to enter Main Menu -> Zone -> Zone List.

(2) Press ▲/▼ key to select a zone from the zone list.

-**Select:** The radio will enable the selected zone.



-**Channel List:** View the channel members of the current zone and allow deletion of channel members.

-**Add Channel:** Add a channel member to the current zone.

-**Edit name:** Reset the zone alias.



7.3.2 Add a zone

(1) Press the  key to enter Main Menu -> Zone -> Add Zone.

(2) Press the  key, enter the zone name via keyboard, and press the  key to delete.

(3) After editing the zone name, press the  key to save.

(4) Press the  key, select the zone you just added and select “Add Channel”.

(5) Press the  key, press ▲/▼ to select one of the channels in the channel list, press the  key to save and return to the previous menu.

7.4 SMS

InBox: Shows all the received messages, and allows forward or delete the message.

New Msg: Create a new message and send to a contact. The maximum number of characters that can be entered in this short message is 128 (64 Chinese characters).

OutBox: Shows all the sent messages, and allows resend, forward or delete of the message.

Quick Text: Pre-saved messages, and allows to send, edit or delete the message.

DraftBox: Draft messages, and allows send, edit or deleting of the message.

7.5 Call Log

Missed: Shows all the missed calls. Allows you to view and delete private call log that were not answered in time, and to Private call or send

message to a contact in the missed call logs.

Answered: Shows all the answered calls. Allows you to view and delete answered private call log, and to private a call log or send message to a contact in the answered call logs.

Sent: Shows all the sent calls. Allows you to view and delete send call logs, and to send message to a contact in the send call logs.

You can do the following with any call log in the Call Log List:

-Press and hold [PTT] to making a call;

-Send a message

-Delete call logs one by one.

-To delete all Missed / Answered / Sent call logs, select “Call Log -> Delete -> Missed / Answered / Sent”.

7.6 Settings

7.6.1 Radio settings

7.6.1.1 Voice Func

You can use this menu to define the radio tone, including whether the tone is on or off.

(1) **Radio Silent:** Set whether the radio works in mute mode or not, when you choose to turn on mute, the radio will not prompt for any operation.

-When the mute off function is turned on, all prompts are turned on.

-When the mute function is turned on, all tones are off and the icon is displayed on the first line of the screen.

(2) **Battery Low:** Whether or not to allow the radio to emit a low battery alarm tone when the battery is low.

(3) **Key Tone:** Set whether or not the terminal user will be prompted when operating the keys (top key, side key, panel key).

(4) **SMS Prompt:** SMS tone allows you to choose whether to issue a tone when the terminal receives a message.

(5) **Group Call:** Set whether to issue a tone when the terminal receives a Group call.

(6) **Private Call:** Set whether to issue a tone when the terminal receives a Private Call.

(7) **Call End:** Set whether to issue a tone when the call hold time (Group call and Private call) ends.

(8) **Talk Permit:** Set whether to issue a tone when the user of the current channel presses PTT to transmit.

(9) **StartUp Sound:** Set whether to issue a tone when the radio is power on.

(10) **Voice Prompt:** When the user switches the current area, channel/characteristics through the terminal menu or knob, the terminal will announce the voice file corresponding to the switched area, channel/characteristics.

(11) **Analog Roger:** Set whether to issue a tone and the type of tone (OFF, TONE, 1200) after the end of transmission in analog mode.

7.6.1.2 Key Functions

SK1, SK2, P1, P2 are customized function keys, which are divided into functions represented by long press and short press. You can set different functions for these keys.

-**Key Lock:** Set the keyboard lock switch, i.e. lock the keyboard automatically or manually.

-**Delay Time:** set the delay time of keypad lock, range is 5-60 seconds, step value is 1 second.

-**Long Press time:** set the length of time for a key operation to be recognized or judged as a long key press, this function is valid for the whole machine. Range 0.5-5 seconds, step value 0.5 seconds.

Through CPS software -> Public -> Key Feature, program and write the long press and short press function definitions of SK1/SK2/P1/P2 keys to the radio.

Programming path via self-Radio: press  key to enter main menu -> Settings -> Radio Settings -> Key Functions.

7.6.1.3 Display Func

(1) Back Light

LCD backlight brightness can be adjusted in 6 levels; 1-6 levels are adjustable, 1 level is the darkest, 6 levels are the brightest.

(2) Back Time

-**Always On:** The backlight is always on.

-5 seconds ~ 5 minutes selectable.

(3) Start Display

- **Char String:** After turning on the power, the radio will display the characters set in the CPS software.

- **Picture:** After power on, the radio will display the Baofeng picture. Picture written by upper computer (support BMP format)

- **Voltage:** After turning on the power, the radio will show the current voltage value of the battery (e.g. Voltage 7.5V)

(4) CHG FontColor

In standby, the channel and other information will display color in white, black, orange, red, yellow, green, cyan, blue. Up to 8 color options.

(5) CH Color A

In standby, the A-band channel and frequency will be displayed in white, black, orange, red, yellow, green, cyan, blue. Up to 8 color options (no zone included).

(6) CH Color B

In standby, the B-band channel and frequency will be displayed in white, black, orange, red, yellow, green, cyan, blue. Up to 8 color options (no zone included).

(7) Zone Color A

In standby, the A-band zone is displayed in white, black, orange, red, yellow, green, cyan, blue. Up to 8 color options (CH channels are not

included).

(8) Zone Color B

In standby, the B-band zone is displayed in white, black, orange, red, yellow, green, cyan, blue. Up to 8 color options (CH channels are not included).

(9) CH Mode Display

CH name: The radio will work in channel mode and display the channel name, and then the programmed VFO/ MR key is not valid.

Frequency: The radio will work in VFO mode and display the frequency, which allows the programmed VFO/MR key to switch the VFO and Memory channels.

(10) Dual Watch

Single Mode: Turns off the sub channel, and the radio will display the main channel only

Double Wait: Turns on the sub channel, and the radio will display both channel. The radio can watch both the A band and B band or frequencies at the same time. The screen displays the **DW** icon. The radio can receive calls from either the primary or secondary frequency.

>> Automatically switches to the prioritized incoming frequency band.

>> Allows manual switching of bands via pre-programmed **[A/B Switch]** keys.

-Single Wait: the radio will display both A and B bands or frequencies, but will only operate on the primary band (the band indicated by the icon is the primary band).

>> No DW icon is displayed on the screen. The radio only receives calls from the primary band, then the secondary band will disable reception of calls.

>> The frequency band can only be switched manually with the pre-programmed **[A/B Switch]** key.

(11) Language

Choose the Chinese or English.

(12) Display DIR

For ease of use in different work scenarios, the radio's display can be reversed in the forward and reverse directions.

-Forward: Normal display mode, suitable for table or handheld scenarios.

-Reverse: The display interface is reversed, suitable for shoulder or waist mounted scenarios.

(13) LED Indicator

Sets whether or not all indicator lights are turned off when the radio is in covert mode.

-On: Turn off all indicator lights when the radio is in covert mode. The radio no longer displays the indicator lights.

-Off: Indicator status remains unchanged when the radio enters covert mode.

NOTE: If the LED indicators are turned off, both the transmit and receive indicators will be off.

(14) Menu Exit Time

You can set the time to exit the menu automatically with this parameter. The menu reset timer is activated after entering the menu, and the menu is exited if there is no panel key or menu-related function programmable key operation before this timer overflows. Value range:

-Off: No limitation. The menu can only be exited by manual operation.

-5 to 60 sec.

(15) Time Set

The real-time clock is used to display the local time in real time and to subsequently apply relevant functions based on that time. For example, message time, call logging time, auto switch on/off time, alarm time, etc.

(15.1) Time

Allows manual setting of hours, minutes, and seconds. Move the cursor with the ▲/▼ keys and enter values with the numeric keys.

(15.2) Date

Allows manual setting of the year, month and day. Move the cursor with the ▲/▼ keys and enter values with the numeric keys.

(15.3) Time Display

Sets whether or not the time is displayed in standby mode.

-On: The clock will be displayed in standby mode.

-Off: The clock will not be displayed in standby mode.

(15.4) Display Format

Setting the standby time display format.

- yyyy/mm/dd;
- dd/mm/yyyy

7.6.1.4 Other Func

(1) Auto Power off

Allow to set automatic power off when not used for a period of 30 minutes, 60 minutes, 120 minutes, 240 minutes, 480 minutes of operation.

Off: Turn off the function.

(2) TX Timer

15S-495S: The TX will be limited in the set time. When this time is reached, the radio will auto stop transmission.

OFF: Turn off the TX time limit, and there is no limit for the transmission time.

(3) TOT Predict

This option allows users to set when the radio will alert the user before terminating the transmission.

Off: This function will be not available.

Range 1 – 10s; Step1

This function will be not available when the TX Time Out Time is set to Infinite.

(4) VOX

Enable the VOX, you can speak into the microphone to start transmitting instead of press the [PTT] key. A total of 9 levels are provided.

VOX SW: Turn on or Turn off the VOX function. To turn on VOX, the screen displays the **V** icon.

Gain Level: Sets the sensitivity of the built-in microphone's acoustic emission. The range of values is from level 1 to level 9, the higher the value, the lower the sensitivity.

(5) VOX Delay

When the VOX is enabled, set up the VOX delay to help to extend the transmission time to avoid stopping a transmission too early. 0.3s-5s, a total of 48 times offered.

(6) Talk Around

When the TX radio and RX radio both are set up with Talk Around on, they can communicate directly without a repeater. The analog channel will use the RX frequency as TX/RX frequency, the RX CTCSS/DCS decode as TX CTCSS/DCS encode.

-On: Enables the Talk Around function. When this function is activated by press the pre-programmed **[Talk Around]** key, the host transmits using the receive frequency, so that the host in transit mode can receive Talk Around host signals.

-OFF: Disables the Talk Around function.

(7) Ana MIC Gain

This option allows users to set the sensitivity of microphone digital mode transmission. The higher the gain is, and the lower the sensitivity will be. Range Level 1 – Level 5. Level 1 is the lowest gain and level 5 is the highest gain.

(8) Digi MIC Gain

This option allows users to set the sensitivity of microphone digital mode transmission. The higher the gain is, and the lower the sensitivity will be. Range Level 1 – Level 5. Level 1 is the lowest gain and level 5 is the highest gain.

(9) Freq Step

2.5K, 5K, 6.25K, 10K, 12.5K, 25K, 50K, 100K total of 8 frequency steps.

(10) Power Save

Turn on the function to extend the battery life.

-**Save Off**: Disable power save features.

-**Save 1:1**: Work 30ms, dormant 30ms.

-**Save 1:2**: Work 30ms, dormant 60ms.

-**Save 1:4**: Work 30ms, dormant 120ms.

When turn on the power save, it may not receive the message in time.

(11) FM Radio

Turn on or turn off the FM radio.

-**On**: Turn on the radio. Enter the radio function screen. Press # to search for stations automatically. You can also manually enter a familiar frequency.

-**OFF**: Turn off the radio.

(12) FM Radio Moni

- Off: When FM radio is used, the radio will not permit a transmission or reception.

- On: When FM radio is used, you can still receive or transmit on the channel.

(13) Weather Alarm

-**Off**: Disables the weather alert feature

-**On**: Allows and enables the weather alert feature (for North America).

With the weather alert feature turned on, the radio will display the weather alert icon. The radio shall detect a 1050Hz signal from the channel and the radio enters triple guard mode, guarding the two radio channels and the weather alert channel.

(14) TBST Sel

TBST frequency is used to activate some dormant repeaters, 1000Hz, 1450Hz, 1750Hz, 2100Hz a total of 4 options are offered.

- **2100Hz**: Press the pre-programmed [TBST Send] key to transmit 2100Hz Tone Burst.

- **1750Hz**: Press the pre-programmed [TBST Send] key to transmit 1750Hz Tone Burst.

- **1450Hz**: Press the pre-programmed [TBST Send] key to transmit 1450Hz Tone Burst.

- **1000Hz**: Press the pre-programmed [TBST Send] key to transmit 1000Hz Tone Burst.

(15) Tail - Squelch Tail Elimination

This function is used eliminate squelch tailnoise between BaoFeng handhelds that are communicating directly (no repeater). Reception of a 55 Hz/120° /180° Tone burst mutes the audio long enough to prevent hearing any squelch tail noise.

Off: Turn off squelch tail elimination.

·55Hz/120° /180°

(16) Ana SQL Level

Adjusts the squelch level to receive signal with different signal strength, and a total of 9 levels offered. The value range is: 0~9, the step value is: 1, the default value is: 3. this function is only valid for analog channel.

- **0**: Squelch is always on.

- **1~9**: Squelch level for audio output when squelch is normal. The smaller the value, the lighter the squelch. On the contrary, the larger the value, the deeper the squelch.

(17) SMS Format

-**H-SMS**: Allows SMS text communication with Hytera DMR radios.

-**M-SMS**: Allows SMS text communication with Motorola DMR radios.

-**D-SMS**: Compatible with DMR Alliance SMS text communication.

(18) PrivateCall Match

-**On**: Private call ID needs to be matched when making a private call.

-**Off**: Ignore the match of DMR ID of individual call, receive and respond to individual call with the same frequency/Color Code/Time Slot.



(19) GroupCall Match

-**On**: Match the receiving group ID for group call.



-**Off**: Ignore the match of group call ID when group call is made, and directly receive and respond to the group call with the same frequency/Color Code/ Time Slot.

7.6.2 Channel Set

7.6.2.1. RX Frequency

Input the RX frequency by keypad, click the  key to save, press  key to return.

7.6.2.2. TX Frequency

Input the TX frequency by keypad, click the  key to save, press  key to return.



FCC Licensing Information

This Baofeng radio operates on Commercial / Land Mobile frequencies which require a license from your local radio authority or the Federal Communications Commission (FCC) for business, personal, education and recreational use. To obtain forms, call the FCC forms hotline at: 1-800-418-3676 or go to <http://www.fcc.gov>. For questions concerning commercial licensing, contact the FCC at 1-888-CALL-FCC (1-888-225-5322).

7.6.2.3. TX Power

Set up the TX power for current channel.

- High Power:** The screen displays the **H** icon. The transmit power meter will be displayed at 100%.
- Low Power:** The screen displays the **L** icon. The transmit power meter will be 30% displayed.
- Middle Power:** The screen displays the **M** icon. The transmit power meter will be 60% displayed.

7.6.2.4. TX Contact

This option allows users to select a regular contact for the current channel. The radio sends a call to this contact if the user presses PTT in standby mode. However, after a group call is received, press PTT within the Group Call Hang Time can talkback to the group, but not initiate a new call. Option Description:

- None:** The user is prevented from initiating a call with PTT in standby mode on the channel.
- Group Call contact:** A call from an individual radio to a group of radios.
- Private Call contact:** A call between two individual radios.
- All Call:** A call from an individual radio to all radios in the system.

7.6.2.5. Color Code

The digital channel should have the same color code for communication as defined by the repeater to be used; which can be programmed in the PC software or defined in the Menu. Radio non-response and pre-programmed color code mismatch channel activity.

-Value range: integer from 0 to 15.

7.6.2.6. Time Slot

Set up Slot 1 or Slot 2 for the current channel.

7.6.2.7. Radio ID

In Digital channel, it will show the DMR ID which can be programmed in the PC software – Digital – DMR ID list- DMR ID. Allows edit and select an ID for the channel, each channel allows one ID.

In Analog channel, it will show the radio self ID which is programmed in PC software – Analog –Analog Contacts.

This menu item allows the end user to view, edit, add a radio ID, or apply a radio ID and assign it to the current channel.

- Select:** Apply the current radio ID and assign it to the current channel.
- Edit ID:** Modify or reset the radio ID.
- Edit Name:** Modify or reset the radio alias. Press the  key to delete forward bit by bit, switch the input method by **[#]** key to edit the radio alias.
- Save:** Save the above radio ID and alias modifications.

Multiple Radio ID's

The DM-32UV radio will allow multiple DMR Radio ID numbers to be used with the radio. This feature will allow one radio to be used for example as a Commercial Radio with its own DMR ID, and at the same time also be used as an Amateur radio with another DMR ID.

7.6.2.8. Channel Type

-**Analog:** Provides analog communication services to users using analog signal. When set to analog, the channel will display ANA.

-**Digital:** Provides digital communication services for users using digital signal. When set to digital, the channel will display DIG.

-**Analog+Digital (A+D TX A):** Mixed analog, allows reception of both analog and digital signals, TX is analog, A+D is displayed.

-**Digital + Analog (D+A TX D):** Mixed digital, allows reception of both analog and digital signals, TX is digital, D+A is displayed.

7.6.2.9. Double Slot

This option decides whether to enable the Double Slot Mode feature for the radio.

Double Slot mode is applied to DMR digital radios. In this mode, one frequency supports calls in two slots synchronously. As for group calls in this mode, the members in the same group call must use the same slot, in order to avoid interfering communications in the other slot.

Option Description

- **On:** To enable the Double Slot Mode feature of the radio. The screen displays  , radios within the same group must use the same time slot (Time Slot 1 or Time Slot 2) to talk.

- **Off:** To disable the Double Slot Mode feature of the radio.

7.6.2.10. Channel Name

Allow reset the channel name, this function is only valid in channel mode.

-Press  key to switch input method, switch between numeric, alphabetic and pinyin input method.

-Pinyin input method, press 1 key to insert symbols such as (,),/,|,\,#. Press 0 to insert space.

-Alphabet input method, divided into upper and lower case, press 2-9 to insert letters.

-Numeric input method, press 0~9 to insert numbers.

7.6.2.11. Rx Group List

It will allow edit the RX Group List and assign a new RX Group List to the channel.

-**None:** The radio can only resolve calls from the transmitting contact associated with the channel setting. When “Transmitting Contact” is set to “None”, the radio cannot resolve any group calls.

-**Rx Group List:** To enter the receive group list, press ▲/▼ to select one in the list. Allow:

-**Apply:** Select the current RX Group List and return to the previous menu.

-**Edit/View List:** View the Rx group members (group call contacts), allow add or delete members.

-**Add Member:** Adds a group call member to the current Rx group list.

-**Remove Group:** Delete a group call contact from the current Rx group list.

-**Edit Name:** Reset the current Rx group alias.

-**Add List:** Use numeric keyboard to name the add list. When you finish edit the name, press the  key to confirm and save and return to the previous menu.

7.6.2.12. New Channel

Creates a new channel, sets the channel type (**Analog/Digital/A+D TX A/D+A TX D**), channel name, Rx frequency and Tx frequency.

Allows you to create a new channel and save the current settings to the new channel.

a. Go to “**New Chan**” and select “**Analog/Digital/A+D TX A/D+A TX D**”.

b. Set the channel name and confirm.

c. Enter the Rx frequency and confirm. Press the  key during the input process to move forward and delete the input frequency.

d. Enter the Tx frequency and confirm to save the added channel.

7.6.2.13. Digital Encryption

Encryption is the use of a key to encrypt voice or data, which can only be decrypted by the receiver if the key is consistent, thus preventing voice and data from being eavesdropped. Set up to 32 sets of encryption keys.

CPS Programming Path: Programming in PC Software - Digital - Encryption System allows editing of key aliases, encryption types, and key values.

Configuration to Channel: Channel - Channel Info - Digital - Key - Encryption Key.

(1) Encrypt Switch

-**On:** Enables the digital encryption function. Encryption is performed when send voice or data.

-**Off:** Disables the digital encryption function. No encryption is performed when send voice or data.

(2) Encrypt List

You can associate any of the defined keys to this channel. The key value is used to encrypt when transmit and to decrypt when receive, and both the sender and receiver use the same key to communicate. The key is used by the digital channel and you can add up to 32 key lists.

-**None:** The encryption function is not used.

The encryption key must be programmed by the host computer, including key name, encryption type (custom encryption, ARC4, AES128, AES256), key value, and key ID.

-**Custom Encryption:** The length of the key value is 14 bits and takes values from 0 to F.

-**ARC4:** The length of the key value is 10 bits and takes values from 0 to F.

-**AES128**: The length of the key value is 32 bits and takes values from 0 to F.

-**AES256**: The key value length is 64 bits and takes values from 0 to F.

Key ID is an index in the encryption key list, mapping to each key value, you can modify the key ID, but you must ensure its uniqueness. The range of values is 1 to 255.

***7.6.2.2. CTCSS/DCS**

CTCSS/DCS is signaling below the audio frequency loaded in the carrier, and the speaker is turned on only when the receiver receives a match to the CTCSS/DCS set here.

(1) Tx CTCSS/DCS

Set Tx CTCSS/DCS only

-**None**: The radio does not Tx CTCSS/DCS when transmit on the current channel.

-**CTCSS**: The radio is required to Tx-CTCSS when transmit on the current channel. Selection range: 67.0~254.1.

-**DCS_N**: The radio is required to Tx-DCS when transmit on the current channel. Selection range: D023N~D754N.

-**DCS_I**: The radio needs to send reverse Tx-DCS when transmit on the current channel. Selection range: D023I~D754I

(2) Rx CTCSS/DCS

Only set the Rx CTCSS/DCS.

-**None**: No Rx CTCSS/DCS is detected when the radio receives a signal.

-**CTCSS**: Detects CTCSS/DCS match when the radio receives a signal. Selection range: 67.0~254.1.

-**DCS_N**: Detect whether the DCS is matched when the radio receives the signal. Selection range: D023N~D754N

-**DCS_I**: Detect whether the DCS match when the radio receives the signal, and end the communication when reverse DCS are detected. Selection range: D023I~D754I

(3) RxTx CTC/DCS

Set when TX and RX CTCSS/DCS are the same.

-**None**: No detection of CTCSS/DCS when the radio receives a signal.

-**CTCSS**: Detect CTCSS match when the radio receives a signal. Selection range: 67.0~254.1.

-**DCS_N**: Detect whether the DCS is matched when the radio receives the signal. Selection range: D023N~D754N

-**DCS_I**: Detect whether the DCS match when the radio receives the signal, and end the communication when reverse DCS are detected. Selection range: D023I~D754I

***7.6.2.5. Band Width**

Selects wide band or narrow band for analog channels.

-**Narrow:** 12.5KHz

-**Wide:** 25.0KHz

*7.6.2.6. Optional Signal

Selects the type of signal used for the channel. Allowed are Dual Tone Multi-Frequency (DTMF), 2TONE, 5TONE, BDC1200.

-**Off:** No signal is configured for the current channel.

- **DTMF:** Dual Tone Multi-Frequency signal (DTMF signaling) is selected for the current channel.

Set the DTMF ID as the default call ID for the current channel. Press the PTT key to send the selected DTMF ID. Edit the DTMF ID in the menu or using the PC program software.

-**2 Tone:** Selects two-tone signal (2 Tone) for the current channel.

-**5 Tone:** Selects five-tone signal (5 Tone) for the current channel.

-**BDC1200:** Selects BDC1200 signal for the current channel.

Sets BDC1200 as the default call ID for the current channel. Press [PTT] to send the selected BDC1200.

*7.6.2.7. PTT ID

Used to determine how the PTT ID is sent under the DTMF, five-tone, and BDC1200 signal systems, i.e., whether or not the PTT ID code is sent when the PTT key is pressed or released.

-**Disable:** no PTT ID is sent. The default is disable.

-**Upline code:** send out the local ID only when the PTT key is pressed.

-**Downline code:** Issues the local ID only when the PTT key is released.

-**Upline Code and Downline Code:** the local ID is issued when the PTT key is pressed and released.

Upline Code: When “Upline Code” or “Both” is selected as the PTT ID type, it is used to set the content of the Upline Code. The input contents are: 0~9, * and #, maximum 8 digits.

Downline Code: When “Downline Code” or “Both” is selected as the PTT ID type, it is used to set the content of the downline code. The input contents are: 0~9, * and #, and the maximum input is 8 digits.

The upper line code and lower line code must be programmed by the CPS software.

*7.6.2.8. RX Squelch Mode

When the analog channel is set up for both CTCSS/DCS decoding and optional signaling, you can set up the RX condition in this menu.

-**Carrier:** You can hear the call once the channel receive matched carrier.

*7.6.2.9. SFT-D

- **Off:** Tx frequency is equal to Rx frequency.

- + **(Positive)**: Tx frequency is equal to the Rx frequency plus the frequency difference frequency (i.e., frequency offset).

The screen displays | + | .

- - **(Negative)**: Tx frequency is equal to Rx frequency minus frequency difference frequency (i.e. frequency offset).

The screen displays | - | .

*7.6.2.10. Frequency Offset

You can set the frequency offset, and the transmit frequency can be derived by adding the receive frequency to the frequency offset. Example:

If you set the Rx frequency: 448.250000MHz

Frequency Offset: -05.000000MHz

Therefore the Tx frequency: 443.250000MHz

7.6.3 Device Info

Press the  key to enter the Main Menu -> Settings -> **Device Info**.

Show the Radio ID, Radio name, serial number, model name, Firmware version, etc.

7.6.4 DTMF (Dual Tone Multi-Frequency)

(1) Digit Duration Time

Used to set the duration of the current DTMF system to send a single DTMF number. The value range is 800-2000ms, and the step value is 10ms.

(2) Digit Gap Time

It is used to set the interval time between DTMF numbers sent by the current DTMF system. The range is 80-2000ms, and the step value is 10ms.

(3) Pre Time

The carrier duration before the radio transmits the first DTMF code, so that the receiver can receive the message more accurately and stably. 300-5000ms: 100-3000ms, step value 20mS. Default value: 300ms.

(4) PTT ID pause time

Each time the PTT key is pressed and held, the fixed and unique personal ID number (identity code) of the radio will be sent out. The receiver will automatically display the personal ID code of the radio when it receives the voice.

This menu allows you to set the PTT ID hang time.

-**Off**: No interval limitation, PTT ID will be transmitted every time the PTT key is pressed.

-5S-75S: During this hang-up time period, no PTT ID will be emitted when the [PTT] key is pressed.

(5) DTMF Side Tone

Used to turn on the side tone of the current DTMF system, i.e., the beep when transmit.

-OFF: When transmit, the unit does not emit the code sound.

-On: When transmit, it is accompanied by the sound of the key and the identity code ANI-ID.

(6) Automatic response

Used to select the Automatic response mode defined by the current DTMF decoding.

-Off: no response.

-Prompt: accompanied by a prompt tone response.

-Prompt sound and response:

7.6.5 BDC1200

(1) Tx PreTime

Used to set the duration of the current BDC1200 systems pre-carrier. It ensures that the user can receive information more accurately and stably.

Value range: 300~5000ms, step value 20ms, default value: 300ms.

(2) PTT ID Decode

Set whether to decode PTT ID code, if this option is enabled, the received PTT ID will be displayed to confirm the identity of the sender.

-Off: Decode PTT ID is not allowed.

-On: Allow to decode PTT ID. Default on

(3) PTT ID Pause Time

Each time the PTT key is pressed and held, the radio's fixed and unique personal ID number (identity code) will be sent out. The receiver will automatically display the personal ID number of that radio when it receives a voice.

This menu allows you to set the PTT ID hang time.

OFF: No interval limitation, PTT ID will be transmitted every time the PTT key is pressed.

5S-75S: During this hang-up time period, no PTT ID will be emitted when the [PTT] key is pressed.

(4) Preamble Bit Synchronization

Sets the number of Bit Synchronization packets to be emitted after transmit the Pre-Carrier; the synchronization packets are used to ensure that transmission and reception are kept in sync.

Value range 0-96, step value 1, default value 5

If you are not a professional, please try not to modify this parameter.

(5) BDC1200 Side Tone

Set to adjust the transmit signal using MSK modulation technique when transmit BDC1200 to avoid hearing signaling noise.

-OFF: Turns off the digital signal squelch function. When transmit, the unit does not emit signaling noise.

-On: Enables the digital signal squelch function. When transmit, it is accompanied by signaling noise.

7.6.6 Two Tones (2 Tone)

(1) Pre Time

Used to set the time interval between press the PTT button and sending the first tone. This interval is used to ensure that the receiver is allowed to stabilize before receiving the first tone. The value range is: 0 to 5000 milliseconds, and the step value is: 100 milliseconds. The default value is: 500 milliseconds.

(2) 1st Tone Duration

Used to set the duration of the first audio sent by the current 2-Tone system. The value range is: 500~4000 milliseconds, and the step value is: 100 milliseconds. The default value is: 1000 milliseconds.

(3) 2nd Tone Duration

Used to set the duration of the second audio sent by the current 2-Tone system. The value range is: 500~4000 milliseconds, and the step value is: 100 milliseconds. The default value is: 3000 milliseconds.

(4) Long Tone Duration

Used to set the duration of the long tone sent by the current 2-tone system. The value range is: 5.0~10.0 seconds, and the step value is: 0.1 seconds. The default value is: 5.0 seconds.

(5) Gap Time

Used to set the interval time between the first audio and the second audio sent by the current 2-Tone system. The value range is: 0~2000 milliseconds, and the step value is: 100 milliseconds. The default value is: 1000 milliseconds.

(6) Side Tone

Used to turn on the side tone of the current 2-tone system, i.e., the beep when firing.

-Off: When transmit, the unit will not emit the sound of the code.

-On: When transmit, it is accompanied by the sound of the key and the identity code ANI-ID.

(7) Auto Reset Time

It is used to set the waiting time for automatic reset of the current 2-tone system. The value range is: 1~255 seconds, the step value is: 1 second. The default value is: 10 seconds.

7.6.7 Five Tones (5 Tone)

(1) Pre Time

Used to set the time interval between press the PTT button and sending the first 5-tone audio. This interval is used to ensure that the receiver is allowed to stabilize before receiving the first tone. The range of values is: 0 to 2550 milliseconds, and the step value is: 10 milliseconds. The default value is: 140 milliseconds.

(2) Standard (5-tone system):

Used to select the signaling standard used by the current 5-tone system. The available options are: ZVET1, ZVET1, ZVET1, CCIR1, CCIR2, CCIR3, EEA, EIA. Default value is: ZVET1.

(3) Decode Response

Used to select the auto response method for the current 5-tone decoding definition. The available options are:

-**None:** No response.

-**Beep Tone:** Response with a prompt tone.

-**Beep Tone & Response:** Response by Prompt Tone + Display ID.

(4) Side Tone

Used to turn on the side tone of the current 5-tone system, i.e., the tone when transmit.

-**OFF:** When transmit, the unit does not emit the sound of the code.

-**On:** When transmit, it is accompanied by the sound of the key and the identity code ANI-ID.

(5) PTT ID pause time

Each time the PTT key is pressed and held down, the radio's fixed and unique personal ID number (identity code) will be sent out. The receiver will automatically display the personal ID number of that radio when it receives the tone.

This menu allows you to set the PTT ID hang time.

OFF: No interval limitation, PTT ID will be transmitted every time the PTT key is pressed.

5S-75S: During this hang-up time period, no PTT ID will be emitted by press the [PTT] key.

(6) Auto Reset Time

Used to set the waiting time for automatic reset of the current 5-tone system. The value range is: 1~255 seconds, and the step value is: 1 second. The default value is: 10 seconds.

7.7 Record

The voice record is designed for security use purpose. Each call will be saved as a separated record file with DMR ID and time details.

The standard voice 10hours record allows in DMR mode only.

7.7.1 Record Switch

Method 1: Press the  key to enter Main Menu -> Record -> Record Switch -> to turn on the record function.

Method 2: Press the pre-programmed **[Record Switch]** key to turn on the record function.

Note: When the record function is turned on, the  screen displays.

7.7.2 Record Selection

The record function of this unit can be directed to select Rx record, or Tx record, or Rx and Tx record.

The menu functions operate as follows:

(1) Press the  key to enter the main menu -> Record -> Record Sel.

(1) Press the  key to select the desired type of record:

-**Rx Record:** Only for incoming calls.



-**Tx Record:** Record for outgoing calls only.



-**Rx/Tx Record:** Record all incoming and outgoing calls.

7.7.3. Record List

Record list management includes playing, deleting, and viewing details.

(1) Press  key to enter Main Menu -> Record -> Record List.

(2) Press / key to retrieve the record entry, then press the  key to select.

-**Play:** The screen displays Record Playback and plays the current entry record. Record playback, one record at a time, you can press / key to switch records without going back to the previous menu.

-**Delete:** Delete the record of the current entry.

-**Detail:** you can view details such as source ID, inbound/outbound, date, time, record duration, etc.

7.7.4. Record Delete

(1) Go to Main Menu -> Record -> Record Delete.

(2) Press the  key and the screen will show “**Confirm Delete?**”.

-Press the  key will delete all record files.

-Press the  key will cancel the deletion and return to the previous menu.

7.8 Roaming

Roaming function enable users to search the roaming channel list by a programmed time interval and lock on the repeater with strongest signal.

7.8.1. One Time Roam

Allow you turn on the roaming manually. After the roaming is finished, it will return to the off state.

Manually Roaming is a onetime action only

(2) Roaming Zone

Roaming Zone: select a Roaming Zone from the list to set it as active zone. You can also scroll down the list of Zones and select Add Channel to add a new channel to the current Roaming Zone.

-**Select:** Select the current roaming zone.

-**Channel List:** View the channel members of the current roaming zone and allow deletion of channels.

-**Add Channel:** Add a channel to the current roaming zone.

-**Edit Name:** Reset the roaming zone name.

Add Zone: Create a new roaming zone and name the zone.

(3) Auto Roaming



Set the fixed time waiting interval to begin automatic roaming when the repeater cannot be found, roaming will begin at the end of this time.

-**Roaming On/Off:** enter (on)/exit (off) roaming.

-**Timed Time:** Set a fixed waiting interval to start automatic roaming if a repeater cannot be found, roaming will start at the end of that time.

7.9. GPS Positioning Function (optional with installed GPS)

7.9.1. GNSS On/Off

-**On:** Enables the GPS positioning function.  Icon is displayed, unsuccessful positioning  icon is displayed, successful positioning  icon is displayed.

- **Off:** Disable the GPS positioning function.

7.9.2. Positioning Information GNSS Info

Positioning success will be displayed:

-Lat :

-Long :

-Speed: km/h

-Altitude: M.

-SA :

-Time:

-Date:

7.9.3. Time Zone

Users can convert UTC time to local time through the Time Zone menu. You can select the time zone that the terminal needs to display from

the drop-down list box, and the terminal will adjust its system time according to the selected time zone. The range is from UTC -12:00 to UTC +13:00, and the default value is UTC +8:00.

7.9.4. Display Format

-DDD: Displayed in degrees.

-DMS: in degrees, minutes and seconds, XXX. /MMM'/SS''

7.9.5. Positioning Mode GNSS Mode

Support GPS, BeiDou. Options:

-GPS

-Beidou

-GPS+Beidou

7.10 APRS Location Reporting (Supported byGPS)

7.10.1. APRS On/Off

-On: Enables the APRS automatic position reporting system. Valid for digital mode only.

-Off: Disables the APRS function.

7.10.2. Upload ID

APRS upload the specified ID.

7.10.3. Upload Type

-Private call: APRS is reported to the specified private call ID.

-Group call: APRS is reported to the specified RX group (group ID).

7.10.4. Report Channel

Allows user to select a channel to transmit the DMR APRS. It can be the current channel or specified channel.

7.10.5 Intervals Set

This function allows you to set DMR APRS to be sent automatically at a fixed time.

-Off: No limitation.

-60s-7650s: upload every 60s-7650s.

7.10.6. APRS Information

View APRS message information

7.10.7. Upload Beacon

GPS Beacon: The APRS will transmit the GPS data, only if the GPS is set to on first, then GPS must also successfully lock on the satellites.

Fixed Beacon: The APRS will transmit the fixed beacon data. Someone can transmit the fixed beacon without setting the GPS on.

The fixed beacon location information should be set in CPS firstly.

NOTE: More settings can only be made from the PC software. cps – Public - APRS, you must check the APRS box before you can add the APRS menu to the left hand numeric menu.

7.10.8. Delete All

Deletes all APRS information.

8. Other Functions

8.1 NoAA weather switch and Weather Alerts



In standby mode, press the [*] key to quickly turn on NOAA channel reception and display the  icon. Press ▲/▼ to select a Weather channel.

Weather channel reception status, press MENU -> Scan -> Scan Switch -> On, enter auto scan.

Scan to active channel, stop automatically, display Weather channel and frequency, turn on speaker to play weather broadcast (radio does not receive radio call).

Press the  key to enter the weather alert option:

-**Off**: Disables the weather alert feature. The warning  icon disappears and only the  icon is displayed.

-**On**: Turns on the weather alert function and the   screen displays . Press the  key to return to the standby screen.

- The radio returns to standby and allows radio calls. The walkie-talkie waits for the radio channel and the weather channel, and automatically scans the radio channel and the weather alert channel cyclically.

- Activate the Weather Alert feature to receive a 1050 Hz alert signal, you will hear a loud beep and the radio will automatically switch to Weather Broadcast mode.

When the NoAA weather function is on, long press the [*] key or  key to exit the NoAA weather scan reception function and return to standby mode.

<i>CH.No.</i>	<i>CH.Freq.</i>	<i>CH.No.</i>	<i>CH.Freq.</i>
1	162.55000	6	162.50000
2	162.40000	7	162.52500
3	162.47500	8	161.65000
4	162.42500	9	161.77500
5	162.45000	10	163.27500

** Channels 8, 9 and 10 are designated as Canadian maritime frequencies. You cannot transmit on these channels.*

8.2 Password service

Set password to manage the terminal, only when the terminal verifies that the password is correct, it is allowed to carry out related operations. You can set frequency reading password, frequency writing password and power-on password through CPS Software -> Public -> Optional Functions -> Password, check them and write them to the radio.

- (1) Read from radio password: Set the password to read data from the radio, up to 8 numbers can be input as password.
- (2) Write to Radio Password: Set the password for write data to the radio, and up to 8 numbers can be entered as the password.
- (3) Power-on Password: The power-on password of the terminal, up to 8 digits can be input as password.

8.3 Resetting the Radio

(1) First turn off the radio power.

(2) Then press and hold the [SK1] and [SK2] keys simultaneously to turn on the power.

(3) The radio will start up and show a dialog box on the display, "Are you sure restoring factory settings?"

-Press the key to exit the reset and restart the radio.

-Press the key to continue the reset and show on the display: "Initializ radio".

NOTE: Resetting the radio can only be performed if the "Allow Reset" option is checked through CPS programming.

8.3 DMR Repeater Configuration

MR channel mode, for example:





The repeater parameters are:

Rx frequency (downstream of the repeater i.e., the TX frequency of the repeater, i.e., the RX frequency of the radio) 422.96250 MHz;

Tx frequency (upstream of the repeater i.e. the RX frequency of the repeater, i.e. the TX frequency of the radio) 412.96250MHz;



Color Code 1; Time Slot 1; TX Contact 1;

8.3.1. Add digital channel, set as follows:











- (1) Press and hold  key to switch to MR channel mode, and press the  key to enter the main menu > Settings > Channel Set.
- (2) Press  key to New chan > Digital; Select digital mode
- (3) Name the channel (press # key to switch to Pinyin/Alphabet/Numeric input method) Edit the channel alias
- (4) Set RX - frequency, enter 42296250 Press  To set receive frequency
- (5) Set TX - frequency, enter 41296250 To set the transmit frequency.

(6) Press  to save the added channel.

8.3.2. New channel is add to the zone with the following settings:

- (1) Press the  key to enter the main menu -> Zone -> Select a Zone and confirm.
- (2) Press  key to select "Add Channel".
- (3) Press  key to select the channel you just added in the channel list and confirm.
- (4) Prompt "Add Success" and return to the previous menu.

8.3.3. Configure the parameters for the new channel as follows:

- (1) Press  key to enter main menu -> Setting -> Channel Set.
- (2) Press  key to Tx Contacts -> Contacts 1 -> Press  To add a TX Contact.
- (3) Press  key to Color Code -> Select 1 -> press  To select a CC
- (4) Press  to Time Slot -> Slot 1 -> Press  To select a Time Slot
- (5) Press  key to Rx Group List -> Rx Group -> Press  To add a RX group.
- (6) Press  key to exit the menu and return to the standby interface.

It is strongly recommended that the terminal sets the power to high power in relay mode.

9. Programming Guide

Baofeng DM-32UV radios ship from the manufacturer "Keypad" locked per FCC rules. You can press the (Menu) key and the (star) key to unlock the keypad for the first time of use. You will need the programming cable to connect your radio to your computer for programming.

The programming software and codeplug programming guide are available for download from Baofeng website: <http://www.baofengradio.com>

When programming this radio for the first time, it is recommended you first READ the radio with the software and then save this file for future reference as it contains the default programming and settings. In addition, after you READ this radio with software, first make your programming and frequency changes, then send this edited file back to your radio.

When using a profile in your hard disk, use the CPS to import and edit it. Then write all data to the radio.

-During reading data from the radio (frequency reading), the PC program is displayed and the red indicator light flashes.

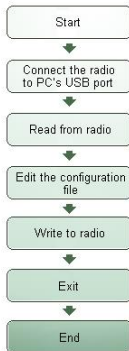

-During the process of writing data to the radio (frequency writing), the PC program is displayed and the green indicator light flashes.

Before programming the radios (Reading or Writing radios data), select the com port correctly and make sure the baud rate is set to 256000.

9.1 Record Management

Enter the record management software through CPS software -> Tools -> Record. You can connect the radio, read out the record records, view the detailed records of each record (Record ID, TX/RX, Call ID, Call Type, Record time, Record duration, etc.) and play or save as WAV file to save the records.

9.2 Firmware Upgrade

You can download program software, firmware (codeplug), program guide from baofeng website: <http://www.baofengradio.com>.

Through CPS software -> Tools -> Firmware Upgrade -> open the file (load .bin file), click upgrade, a dialog box prompts "Please hold down the [PTT+SK1] key to open the radio", according to the dialog box prompts and hold down the [PTT] and [SK1] keys to open the radio (the indicator light is on green), click "Upgrade", click "Upgrade", then press [PTT] and [SK1] keys to open the radio (the indicator is on green). "Upgrade", the red light flashes until the upgrade is completed.

Before firmware upgrade, please select the com port correctly and set the baud rate to 11520.

9.3 Internal Parameters

Edit model information, band information, function options (value-added function open).

9.4 Tuning and testing items

The radio enters the test mode and the debugging of technical indexes (read first, then modify, then write).

9.5 Download language and character libraries

Download voice files, Chinese character libraries, English character libraries and other arbitrary files.

9.6 Power-on picture

Update the power-on picture, the format of the power-on picture is .bmp. The size and resolution of the picture is 160*128(1.77 inch), 240*320(2.00 inch).

9.7 Amateur DMR-MARC

For the best Amateur DMR experience obtain a subscriber ID from one of many available Amateur Radio sources. A U.S. Amateur can obtain a DMR ID From: <https://www.radioid.net/cgi-bin/trbo-database/register.cgi> For DMR repeaters in your area please see: www.repeaterbook.com World DMR repeater network map:

<https://www.repeaterbook.com/index.php/repeater-database> World DMR repeater network with verified Talkgroups by

activity:<https://brandmeister.network/?page=lh>

9.8 Global Amateur Contact Database (.csv)

The DM-32UV DMR radios contain a separate database memory for importing and displaying Amateur DMR individual IDs, call sign and user name in comma-delimited format (.csv). Please reference in the programming guide for import and export database operations detailed.

User List Contact Database: <https://ham-digital.org/status/>

10. On-Line Service and Support

The Baofeng website provides additional information about obtaining service or support for the Baofeng line of two-way radios and accessories.

Visit: www.baofengradio.com

Warning Notes

Every effort has been made to ensure that the information in this document is complete, accurate, and up to-date. Baofeng Radio assumes no responsibility for the results of errors beyond its control. The manufacturer of this equipment also cannot guarantee that changes in the equipment made by non-authorized users will not affect the information in it.

FCC Licensing Information

The Baofeng radio operates on Commercial / Land Mobile frequencies which require a license from the Federal Communications Commission (FCC) for business, personal, education and recreational use. To obtain forms, call the FCC forms hotline at: 1-800-418-3676 or go to <http://www.fcc.gov>.

For questions concerning commercial licensing, contact the FCC at 1-888-CALL-FCC (1-888-225-5322).

Appendix A. - Troubleshooting

Due to its sturdy design, your radios requires almost no maintenance. However, it is a sophisticated electronic instrument, so the following precautions should be followed:

If the antenna is damaged, do not transmit except in emergency situations. Antenna failure to transmit may cause further radio damage.

You are responsible for continuing to perform FCC technical compliance checks on the radio.

You should arrange regular performance checks with your dealer.

Phenomena	Solution
The radio cannot be switched on or no display after being switched on.	Battery pack may not be installed properly. Remove the battery pack and install it again.
	Battery power may be insufficient. Recharge or replace the battery pack.
The battery doesn't last very long after charging.	The battery is defective; please replace it with a new battery pack.
Cannot talk to or hear other members in your group.	1. Make sure the frequency and CTCSS are the same as other members.
	2. Make sure you are within range, and not too far away from your member.
	3. Make sure you are set in correct digital mode, and frequency.
	4. In digital mode, make sure set correct code and encrypt group is used in current channel.
	5. In digital mode, make sure set correct receiving contacts and receiving group is used.
Other voices from Non group members are heard on the channel.	Analog: Change the CTCSS/DCS Tone and make sure to change the tone on all radios in your group.
Digital channel can not Private call, Group call,	Check the Color Code, Time Slot, Tx Contacts, arranged to Rx Group List is correct

****If the above solutions cannot fix your problems, or you may have some other queries, please contact your dealer for more technical support.***

Appendix B. - Technical specifications

General	
Frequency Range	Sanning Receiver : VHF136.0-174.0MHz/UHF400.0-480.0MHz/AM108-136MHz/FM65-108 Transmit: 144-148MHz/420-450MHz(V04) 144-146MHz/400-429.995MHz/450-69.990MHz(V05) 144-146MHz/430-440MHz(V06) 136-174MHz/400-438MHz(V07) 136-174MHz/400-480MHz(V00)
Memory Channel	4000 channels
Digital Contacts	800+50000(.csv)
Channel Spacing	25KHz (Wide Band) ,12.5KHz (Narrow Band)
Frequency Stability	±2.5ppm
Operating Temperature	-10°C~+55°C
Operating Voltage	7.4V DC ±20% /(2500mAh)
Size	182×67×41mm (with battery pack)
Weight	350g (with battery pack, antenna)
Transmitting Part	
Output power	High:8W,Middle:4W,Low:1W
Output Consumption	Analog≤2.6A, Digital≤1.5A
Consumption	≤0.18A
FM modulation	16KCF3E@25KHz, 141KCF3E@20KHz, 11KCF3E@12.5KHz
4FSK digital modulation	12.5KHz for data:7K60FXD, 12.5KHz for data and voice :7K60FXE
Modulation Distortion	≤5%
Signal-to-noise(wide/narrow)	≥45dB@25KHz, ≥40dB@12.5KHz
Adjacent Channel power	≤-65dB, ≤-60dB
Audio Response	+1~3dB
Antenna Port Spurious	9KHz-1GHz: ≤-20dBm, 1GHz-12.75GHz: ≤-20dBm

Digital Protocol	ETSI-TS102 361-1,-2,-3
Vocoder type	AMBE+2™
Receiving Part	
Analog receive sensitivity	-122dBm (12dB SINAD)
Digital receive sensitivity	-120dBm (BER≤5%)
Audio power	≤1W
Audio distortion	<10%
Audio response	+1~-3dB
Signal imitation	≥70dB
Inter-mediation (Wide/ narrow)	≥62dB/≥58dB
Adjacent channel selectivity	≥65dB/≥60dB
Receive Current	≤380mA
PM noise	≥45dB@25KHz /≥40dB @12.5KHz

****All specifications may be modified without prior notice or liability.***



You can use the programming cable with a PC to program the frequency, channel type, power etc. your programming must comply with your FCC , CE, UKCA, IC (or other country) license certification.

Appendix C. - CTCSS table

CTCSS Frequencies

Number	Frequency	Number	Frequency	Number	Frequency	Number	Frequency	Number	Frequency
1	67.0	2	69.3	3	71.9	4	74.4	5	77.0
6	79.7	7	82.5	8	85.4	9	88.5	10	91.5
11	94.8	12	97.4	13	100	14	103.5	15	107.2
16	110.9	17	114.8	18	118.8	19	123.0	20	127.3
21	131.8	22	136.5	23	141.3	24	146.2	25	151.4
26	156.7	27	159.8	28	162.2	29	165.5	30	167.9
31	171.3	32	173.8	33	177.3	34	179.9	35	183.5
36	186.2	37	189.9	38	192.8	39	196.6	40	199.5
41	203.5	42	206.5	43	210.7	44	218.1	45	225.7
46	229.1	47	233.6	48	241.8	49	250.3	50	254.1

Appendix D. - DCS table

DCS Codes

Number	Code	Number	Code	Number	Code	Number	Code	Number	Code
1	D023N	2	D025N	3	D026N	4	D031N	5	D032N
6	D036N	7	D043N	8	D047N	9	D051N	10	D053N
11	D054N	12	D065N	13	D071N	14	D072N	15	D073N
16	D074N	17	D114N	18	D115N	19	D116N	20	D122N
21	D125N	22	D131N	23	D132N	24	D134N	25	D143N

26	D145N	27	D152N	28	D155N	29	D156N	30	D162N
31	D165N	32	D172N	33	D174N	34	D205N	35	D212N
36	D223N	37	D225N	38	D226N	39	D243N	40	D244N
41	D245N	42	D246N	43	D251N	44	D252N	45	D255N
46	D261N	47	D263N	48	D265N	49	D266N	50	D271N
51	D274N	52	D306N	53	D311N	54	D315N	55	D325N
56	D331N	57	D332N	58	D343N	59	D346N	60	D351N
61	D356N	62	D364N	63	D365N	64	D371N	65	D411N
66	D412N	67	D413N	68	D423N	69	D431N	70	D432N
71	D445N	72	D446N	73	D452N	74	D454N	75	D455N
76	D462N	77	D464N	78	D465N	79	D466N	80	D503N
81	D506N	82	D516N	83	D523N	84	D526N	85	D532N
86	D546N	87	D565N	88	D606N	89	D612N	90	D624N
91	D627N	92	D631N	93	D632N	94	D645N	95	D654N
96	D662N	97	D664N	98	D703N	99	D712N	100	D723N
101	D731N	102	D732N	103	D734N	104	D743N	105	D754N
106	D023I	107	D025I	108	D026I	109	D031I	110	D032I
111	D036I	112	D043I	113	D047I	114	D051I	115	D053I
116	D054I	117	D065I	118	D071I	119	D072I	120	D073I
121	D074I	122	D114I	123	D115I	124	D116I	125	D122I
126	D125I	127	D131I	128	D132I	129	D134I	130	D143I
131	D145I	132	D152I	133	D155I	134	D156I	135	D162I
136	D165I	137	D172I	138	D174I	139	D205I	140	D212I
141	D223I	142	D225I	143	D226I	144	D243I	145	D244I
146	D245I	147	D246I	148	D251I	149	D252I	150	D255I
151	D261I	152	D263I	153	D265I	154	D266I	155	D271I

156	D274I	157	D306I	158	D311I	159	D315I	160	D325I
161	D331I	162	D332I	163	D343I	164	D346I	165	D351I
166	D356I	167	D364I	168	D365I	169	D371I	170	D411I
171	D412I	172	D413I	173	D423I	174	D431I	175	D432I
176	D445I	177	D446I	178	D452I	179	D454I	180	D455I
181	D462I	182	D464I	183	D465I	184	D466I	185	D503I
186	D506I	187	D516I	188	D523I	189	D526I	190	D532I
191	D546I	192	D565I	193	D606I	194	D612I	195	D624I
196	D627I	197	D631I	198	D632I	199	D645I	200	D654I
201	D662I	202	D664I	203	D703I	204	D712I	205	D723I
206	D731I	207	D732I	208	D734I	209	D743I	210	D754I

Disposal of your Electronic and Electric Equipment

Products with the symbol (crossed-out wheeled bin) cannot be disposed as household waste. Electronic and Electric Equipment should be recycled at a facility capable of handling these items and their waste by products. In EU countries, please contact your local equipment supplier representative or service center for information about the waste collection system in your country.



Attention in case of use

This transceiver works on frequencies which are not generally permitted. As for the actual usage, the user has to possess an amateur radio license. Usage is allowed only in the frequency bands which are allocated for amateur radios.

List of national codes						
AT	BE	BG	CY	CZ	DE	
DK	ES	EE	FI	FR		
GR	HR	HU	IE	IT	LT	
LU	LV	MT	NL	PL	PT	
RO	SK	SI	SE	CH	IS	
LI	NO	-	-	-	-	

Warning Notes

Every effort has been made to ensure that the information in this document is complete, accurate, and up to-date. Wanneton Radio assumes no responsibility for the results of errors beyond its control. The manufacturer of this equipment also cannot guarantee that changes in the equipment made by non-authorized users will not affect the information in it.

Disclaimer

The accuracy and completeness of the contents are sought in the process of compilation, but we do not bear any responsibility for the possible errors or omissions. With the continuous development of technology, we reserve the right to change the design and specification of the product without notice. No copy, modification, translation and dissemination of this handbook may be made in any form without the prior written authorization of our department.

Changes or modifications made to this device, not expressly approved by Baofeng, could void the authority of the user to operate this equipment. All operators using Private Land Mobile frequencies obtain a radio license before operating their equipment.

PO FUNG ELECTRONIC (HK) INTERNATIONAL GROUP COMPANY LIMITED

Address: Room 1508, 15/F, Office Tower II, Grand Plaza, 625 Nathan Road, Kowloon, Hong Kong

E-mail: wangjianhui@baofengradio.com

Http://www.baofengradio.com

Made in China

Print version: DM32UV_EN_V1.0