

# **USER'S MANUAL**

TWO WAY RADIO

# PREFACE

Thank you for purchasing GM-15Pro Two Way Radio, It is a multitask GMRS transceiver. Combining the latest technology in radio communication along with a sturdy mechanical frame, P15UV is the ideal and effective solution for the professionals who need to stay in touch with the working team (in construction sites, buildings, shows, trade fairs or hotels) or for leisure users that just want to keep up with friends and family.

**This manual is applicable to the following product: GM-15PRO, P15UV, GM-30, BF-UV15, UV15IC, UV15R, G-15UV, TH-15S and AI-15X Two Way Radios.**

## IMPORTANT NOTICE

To help you ward off bodily injury or property loss that may arise from improper operation, please read all the information carefully before using our products. This contains instructions for safe usage and RF energy awareness and control for compliance with applicable standards and regulation.

### Safety Information for Baofeng Radios

Your wireless handheld portable transceiver contains a low power transmitter. When the talk button is pushed, it sends out radio frequency (RF) signals. The device is authorized to operate at a duty factor not to exceed 50%. In August 1996, the Federal Communications Commissions (FCC) adopted RF exposure guidelines with safety levels for handheld wireless devices.

# Table of Contents

## **1. GETTING STARTED**

---

1.1 Regulations and Safety Warnings	01
1.2 Content of the packaging	04
1.3 Main features	04
1.4 Maintenance	05

## **2. BATTERY INFORMATION**

---

2.1 Charging the Battery Pack	06
2.2 Charger Supplied	06
2.3 Use Caution with the Li-ion Battery	06
2.4 How to Charge	07
2.5 LED Indicator	07
2.6 How to Store the Battery	08
2.7 Using the Type-C USB Charger	08

## **3. INSTALLATION OF ACCESSORIES**

---

3.1 Installing / Removing the Antenna	09
3.2 Installing the belt clip	09
3.3 Installing the battery pack	09

## **4. RADIO OVERVIEW**

---

4.1 Buttons and controls of the radio	10
4.2 Main controls and parts of the radio	12
4.3 Status Indications	13
4.4 Main keypad controls	13

## **5. BASIC OPERATIONS**

---

5.1 Power on the radio	15
5.2 Adjusting the volume	15

5.3 Channel selection	15
5.4 Making a call	16
5.5 Frequency (VFO) mode	16
5.6 Channel (MR) mode	17

## **6. ADVANCED FEATURES**

---

6.1 Frequency scanning	17
6.2 Channel scanning	18
6.3 CTCSS scanning	18
6.4 DCS scanning	18
6.5 Cursor→Conversion (A/B)	18
6.7 Keypad lock	19
6.8 FM Radio (FM)	19
6.9 TX 1000Hz, 1450Hz, 1750Hz, 2100Hz repeaters tone	19
6.10 Manual Programming (Channels Memory)	19
6.11 Built-in LED Flashlight	21
6.12 NOAA weather Receiver /Scan	21

## **7. WORKING THE MENU SYSTEM**

---

7.1 Basic use	22
7.2 Using short-cuts	22
7.3 Functions and operations	23

## **8. ON-LINE SERVICE AND SUPPORT**

---

Appendix A. - Trouble shooting guide	33
Appendix B. - Technical Specifications	34
Appendix C. - Shortcut Menu operations	35

# 1. GETTING STARTED

## 1.1 Regulations and Safety Warnings

This device complies with Part 15 of the FCC Rules. Operation is subject to the following two conditions:

(1) This device may not cause harmful interference.

(2) This device must accept any interference received, including interference that may cause undesired operation.

**Important:** Any changes or modifications not expressly approved by the party responsible for compliance could void the user's authority to operate this device. Your radio is set up to transmit a regulated signal on an assigned frequency. It is against the law to alter or adjust the settings inside the radio to exceed those limitations. Any adjustments to your radio must be made by qualified technicians.

To be safe and sure:

- Never open your radio's case.
- Never change or replace anything in your radio except the battery.

Your radio might cause TV or radio interference even when it is operating properly. To determine whether your radio is causing the interference, turn it off. If the interference goes away, your radio is causing it. Try to eliminate the interference by moving your radio away from the receiver. If you cannot eliminate the interference, the FCC requires that you stop using the radio.

**Hazardous Environments:** Do not operate the radio in hazardous environments. Explosion or fire may result.

Do not operate the radio near unshielded electrical blasting caps.

Under certain conditions, radios can interfere with blasting operations and may cause an explosion. Turn your radio OFF to prevent accidental transmission when in a blasting area or in areas posted: "Turn off two-way radio." Construction crews often use remote control RF devices to set off explosives.

**Care and Safety:** To clean the radio, use a soft cloth dampened with water. Do not use cleaners or solvents because they can harm the body of the unit and leak inside, causing permanent damage. Use a dry, lint-free cloth to clean the battery contacts.

## RF Exposure Information

**WARNING!** Read this information before using the radio. In August 1996 the Federal Communications Commission (FCC) of the United States with its action in Report and Order FCC 96-326 adopted an updated safety standard for human exposure to radio frequency electromagnetic energy emitted by FCC regulated transmitters.

Those guidelines are consistent with the safety standard previously set by both U.S. and international standards bodies. The design of the radio complies with the FCC guidelines and these international standards.

Never allow children to operate the radio without adult supervision and the knowledge of the following guidelines.

**WARNING!** It is up to the user to properly operate this radio transmitter to insure safe operation. Please adhere to the following:

Use only the supplied or an approved antenna. Unauthorized antennas, modifications, or attachments could impair call quality, damage the radio, or result in violation of FCC regulations.

Do not use the radio with a damaged antenna.

If a damaged antenna comes into contact with the skin, a minor burn may result. Please contact your local dealer for a replacement antenna.

### Hand-held Operation (Held-to-Face)

This device was evaluated for typical hand-held (held-to-face) operations with a 1 inch spacing from the front of the radio. For hand-held operation, the radio should be held 1 inch from the user's face in order to comply with FCC RF exposure requirements.

For more information about RF exposure, please visit the FCC web site at [www.fcc.gov](http://www.fcc.gov).

### Body-worn Operation

This device was evaluated for body-worn operations with the supplied belt-clip accessory. (All necessary accessories are included in the package; any additional or optional accessories are not required for compliance with the guidelines.) Third party accessories (unless approved by the manufacturer) should be avoided as these might not comply with FCC RF exposure guidelines.

For more information about RF exposure, please visit the FCC web site at [www.fcc.gov](http://www.fcc.gov).

## GMRS Communication

This GMRS (General Mobile Radio Service) feature is a land-mobile service available for short-distance, two-way communications in the USA. You must have a valid FCC license to communicate on these channels. The GMRS/FRS frequencies that this radio uses are set aside for communicating with others while hiking, biking, and working; keeping track of family and friends at a crowded public event; checking with travel companions in another car; talking with neighbors; arranging meeting spots with others while shopping at the mall. Licensed users will be issued a call sign by the FCC, which should be used for station identification when operating this radio. GMRS users should also cooperate by engaging in permissible transmissions only, avoiding channel interference with other GMRS users, and being prudent with the length of their transmission time.

## FCC License Required

This two-way radio operates on GMRS (General Mobile Radio Service) frequencies which require an FCC (Federal Communications Commission) license. A user must be licensed prior to transmitting on the GMRS band with this radio. Serious penalties could result for unlicensed use of GMRS channels, in violation of FCC rules. Operation of this radio is subject to additional rules specified in 47 C.F.R. Part 95. For licensing information and application forms, please call the FCC Hotline at 800418-FORM. Request form #159 and form #605. Questions regarding the license application should be directed to the FCC at 888-CALL-FCC. Additional information is available on the FCC's website at [www.fcc.gov](http://www.fcc.gov).

**NOTE:** Even if you operate this radio on FRS (Family Radio Service) channels at low power (0.5 watt), you are required to have an FCC license. Because this radio operates in the 0.5 to 5 watt GMRS power range all GMRS rules apply and will require you have a GMRS license even for FRS (Family Radio Service) communication. Normal FRS only radios operate at a maximum power of 0.5 watt (500 mill watt) power and have an integral (non-detachable) antenna.

## FCC Warnings

Replacement or substitution of transistors, regular diodes or other parts of a unique nature, with parts other than those recommended by Pofung/Baofeng may cause a violation of the technical regulations of part 95 of the FCC rules, or violation of type acceptance requirements of part 2 of the rules.

## 1.2 Content of the packaging

- 1 GM-15Pro transceiver
- 1 Fast desktop charger
- 1 Belt clip

- 1 Li-Ion battery pack 1500mAh 7.4V
- 1 Wall adaptor

**If any item is missing, please verify with your dealer.**

## 1.3 Main features

- 22 Modifiable GMRS Channels (RX &TX)
- Channel and frequency mode (MR/VFO) are selectable
- Scanner function, precise setting of scanning frequency range, useful frequencies can be saved as channels
- 220 Programmable Scanner Channels (Receive Only)
- Output power: 5W/0.5W (GMRS)
- 154 Privacy Codes (50 CTCSS codes/ 104 DCS codes)
- SOS Emergency function
- Built-in FM Radio (88-108MHz)
- 2pin Kenwood accessory jack
- TOT (Time out timer)
- Reverse function
- Busy Channel Lockout function (BCL)
- Frequency step: 2.5/5/6.25/10/12.5/25KHz
- Squelch adjustable in 9 levels
- Li-Ion 1500mAh battery pack
- Support Type-C direct charging and charging dock, making battery life more convenient
- 8 Modifiable GMRS Repeater Channels (RX & TX)
- Dual band, dual display & dual band single display (SYNC) set
- Large screen, full keyboard, open menu operation, get rid of the shackles of programming software
- 11 NoAA weather channels to receive and scan
- CTCSS and DCS codes Scan
- 1750Hz tone for repeaters
- Three scan recovery methods: carrier, search, time
- VOX, Channels Scan, Frequency Scan, Dual Watch functions
- Channel or frequency mode selection
- DTMF function
- Setting and storing of channel names
- VOICE: vocal indication of the function selected
- Repeater shift
- Power Save



## About Range

Your GM-15Pro Series radios are designed to give you maximum range under optimum conditions.

- Maximum Range: Little to No sight Obstruction.
- Medium Range: Partial Obstruction to line of sight.
- Short Range: Major Obstruction to Line of Sight.

### Optimum Conditions are:

- Over water
- Open rural areas without obstructions
- Flat areas where you can see the other person

### To ensure you get maximum range:

- Be sure to use fresh or fully charged batteries - low batteries will cause low power conditions.
- Be sure you are on a GMRS channel - FRS channels are restricted by the FCC to low power.
- Be sure to set your radio to use Hi power.

## 1.4 Maintenance

Your Two Way Radio is an electronic product of exact design and should be treated with care.

The suggestions below will help you to fulfill any warranty obligations and to enjoy this product for many years.

- Do not attempt to open the radio for any reason! The radio's precision mechanics and electronics require experience and specialized equipment; for the same reason, the radio should under no circumstances be realigned as it has already been calibrated for maximum performance. Unauthorized opening of the transceiver will void the warranty.
- Do not store the Radio under the sunshine or in hot areas.
- High temperatures can shorten the life of electronic devices, and warp or melt certain plastics.
- Do not store the radio in dusty and dirty areas.
- Keep the Radio dry. Rainwater or damp will corrode electronic circuits.

- If it appears that the Radio diffuses peculiar smell or smoke, please shut off its power immediately and take off the charger or battery from the radio.
- Do not transmit without antenna.

## **2. BATTERY INFORMATION**

### **2.1 Charging the Battery Pack**

The Li-ion battery pack is not charged at the factory; please charge it before use. Charging the battery pack for the first time after purchase or extended storage (more than 2 months) may not bring the battery pack to its normal maximum operating capacity. Best operation will require fully charging/ discharging the battery two or three times before the operating capacity will reach its best performance. The battery pack life may be depleted when it's operating time decreases even though it has been fully and correctly charged. If this is the case, replace the battery pack.

### **2.2 Charger Supplied**

Please use the specified charger provided by POFUNG/Baofeng. Other models may cause explosion and personal injury. After installing the battery pack, and if the radio displays low battery with a voice prompt, please charge the battery.

### **2.3 Use Caution with the Li-ion Battery**

- a. Do not short the battery terminals or throw the battery into a fire. Never attempt to remove the casing from the battery pack, as POFUNG/ Baofeng cannot be held responsible for any accident caused by modifying the battery.
- b. The ambient temperature should be between 5°C-40°C (40°F - 105°F) while charging the battery. Charging outside this range may not fully charge the battery.
- c. Please turn off the radio before inserting it into the charger. It may otherwise interfere with correct charging.
- d. To avoid interfering with the charging cycle, please do not cut off the power or remove the battery during charging until the green light is on.
- e. Do not recharge the battery pack if it is fully charged. This may shorten the life of the battery pack or damage the battery pack.

f. Do not charge the battery or the radio if it is damp. Dry it before charging to avoid damage.

## **WARNING !**

**When keys, ornamental chain or other electric metals contact the battery terminal, the battery may become damaged or injure a human. If the battery terminals are short circuited it will generate a lot of heat. Take care when carrying and using the battery. Remember to put the battery or radio into an insulated container. Do not put it into a metal container.**

## **2.4 How to Charge**

- a. Plug the AC adaptor into the AC outlet, and then plug the cable of the AC adaptor into the DC jack located on the back of the charger. The indicator light blinks orange and is then ready to charge a battery.
- b. Plug the battery or the radio into the charger. Make sure the battery terminals are good in contact with charging terminals. The indicator light turns to red--- charging begins.
- c. It takes approximately 2-5 hours to fully charge the battery. When the lamp lights green, the charging is completed. Remove the battery or the radio unit with its battery from socket.

**When charging a radio (with battery) the indicating lamp will not turn into green to show the fully charged status if the radio is powered on. Only when the radio is switched off will the lamp indicate normal operation. The radio consumes energy when it is power-on, and the charger cannot detect the correct battery voltage when the battery has been fully charged. So the charger will charge the battery in constant voltage mode and fail to indicate correctly when the battery has been fully charged.**

## **2.5 LED Indicator**

<b>STATUS</b>	<b>LED</b>
No Battery	Green and red alternately flashing
Charge Normally	Red
Fully Charged	Green

**NOTE: Trouble means battery too warm, battery short-circuited or charger short-circuited.**

## 2.6 How to Store the Battery

- a. If the battery needs to be stored, keep it in status of 80% discharged.
- b. It should be kept in low temperature and dry environment.
- c. Keep it away from hot places and direct sunlight.
  - » Do not short circuit the battery terminals.
  - » Never attempt to remove the casing from the battery pack.
  - » Never store the battery in unsafe surroundings, as a short may cause an explosion.
  - » Do not put the battery in a hot environment or throw it into a fire, as it may cause an explosion.

## 2.7 Using the Type-C USB Charger

The micro-USB charger is a handy port that allows you to conveniently charge your Li-ion battery pack.

1. Make sure your radio is turned OFF.
2. Plug the Type-C USB cable into the Type-C USB charging port on your battery. Connect the other end of the micro-USB charger to wall power outlet.
3. An empty battery will be fully charged in 4 hours.
4. The battery meter on LCD will move to indicate the battery is charging.

Note:

- It is recommended to power OFF your radio while charging. However, if power is turned on while charging, you may not be able to transmit a message if the battery is completely empty. Allow time for the battery to charge to 1 bar before attempting to transmit a message.
- For optimal battery life, remove the radio from the charger within 6 hours. Do not store the radio while connected to the charger.

## 3. INSTALLATION OF ACCESSORIES

Before the radio is ready for use we need to attach the battery pack, as well as charge the battery.

### 3.1 Installing the belt clip

- a. At the back of the radio there are two parallel screws mounted above the battery, remove these and thread them through the holes on the belt clip as you screw them back into the radio body.
- b. Removing the Belt Clip: Unscrew counter-clockwise to remove the belt clip.

### 3.2 Installing the battery pack

Before attaching or removing the battery make sure your radio is turned off by turning the power/volume knob all the way counter-clockwise.

- a. Make sure the battery is aligned in parallel with the radio body with the lower edge of the battery about 1-2cm below the edge of the radio.
- b. Once aligned with the guide-rails, slide the battery upward until you hear a click as the battery locks in place.

#### Remove the battery pack



To remove the battery, press the battery release above the battery pack, as you slide the battery downward.

### 3.3 Installing the Additional Speaker/Microphone (Optional)

Pry open the rubber MIC-Headset jack cover and then insert the Speaker / Microphone plug into the double jack.

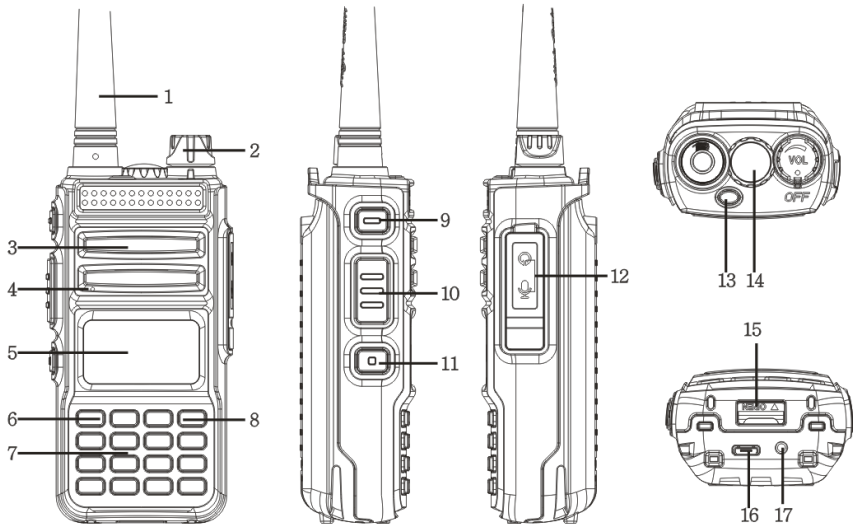
## 4. RADIO OVERVIEW



1. Antenna
2. Power Switch / Volume control: Rotate to switch on/off the radio and adjust the volume
3. Speaker
4. Microphone
5. LCD display
6.  (MENU) key: enter the MENU functions and confirms the selection. In standby mode, press and hold the key to switch between frequency mode and MENU channel mode. Press and hold down the MENU key to switch between the frequency mode and channel mode.
7. Alphanumeric keypad.
8.  (Back/WX) key: press to exit the Menu and functions. A/B (appears on the display): push to select the desired. Press and hold this key for 5 seconds to switch between GMRS communication and NoAA weather reception mode.
9. FM/SOS key: Press it for a short time to turn on the FM radio. Press it again to turn it off. Press and hold the key to turn on the audible and visual alarm function
10. PTT key: Transmit key, hold the key to speak, release the key after speaking, and receive incoming calls.
11. LAMP/Monitor key: Press the key once to turn on the flashlight, Press and hold the key again to flash the flashlight, and press the hand again to turn off the flashlight. Press and hold to enter MONITOR mode.
12. MIC/SP: External speaker/mike jacks.
13. Led: transmission (red) / reception (green)
14. Flashlight
15. Battery release latch
16. Type-C Charging Port: DC5V USB input
17. Charging indicator: The red light is always on during charging, and the green light is always on when charging is full.

## 4.2 Main controls and parts of the radio

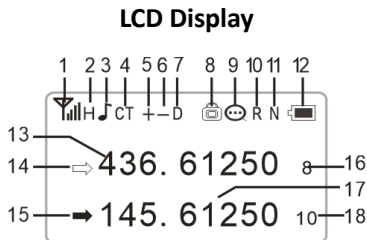

1. Received signal strength.
2. **High/Low** power selection.
3. Appears when **DTMFST (DT-ST / DT + ANI / ANI-ST)** is activated.
4. These symbols show that you set a **DCS** or **CTCSS** code in tx or rx. In tx mode it appears while you are transmitting, while in rx mode it is shown also in stand-by condition.
5. Appears when a **positive shift** is activated.
6. Appears when a **negative shift** is enabled.
7. This letter is displayed when the **Dual Watch** function is active.
8. This icon indicates the **keypad lock**. To unlock it press [\*][7][0].
9. **VOX** function enabled.
10. **Reverse** frequency
11. **Narrow bandwidth**: N = narrow. When the wide (W) bandwidth is activated, no icon is displayed.
12. **Battery level indicator**. When the battery is almost used up, the icon starts blinking and the transmission is blocked. Charge the radio.



13/17. Depending on the setting, it will show the frequency in use, the channel name, the menu setting, etc

14/15. Indicates the **VFO** in use and the current menu or function setting. This icon is displayed close to the band in use or to the menu settings.

16/18. Indicates the **channel number** that you stored

## Battery Level Indicator

When the battery level indicator reads  the battery is depleted. At this point the radio will start beeping periodically as well as flash the backlight of the display and when voice prompts are enabled, a "Low Voltage" announcement will be heard, indicating that you need to change your battery or put your radio in the charger.

## 4.3 Status Indications

The status LED has a very simple and traditional design.

LED Indicator	Radio Status
Constant Red	Transmitting.
Constant Green	Receiving.

## 4.4 Main keypad controls

- ☐ (MENU) key: It is used for activating the MENU, choose each MENU selection and confirm the parameter.  
In standby mode, press and hold the key to switch between frequency (VFO) mode and channel (MR) mode.  
To save frequencies to channel memory you must be in Frequency (VFO) mode. Memory mode is sometimes also referred to as Channel mode.
- ↗ key: Press it for more than 2 seconds, the channel and frequency will move upwards rapidly; in SCAN mode, press this control to move the scanning upwards.
- ↘ key: Keep it pressed it for more than 2 seconds, the channel and frequency will move downwards rapidly; in SCAN mode, press this control to move the scanning downwards.
- 🔍 key: press to exit the Menu and functions. A/B (appears on the display): push to select the desired frequency (VHF

or UHF) in the main or secondary display. When listening to broadcast FM, the  key switches between 65-75 MHz and 76-108 MHz band. Press and hold this key for 5 seconds to switch between GMRS communication and NOAA weather reception mode.

## • Numeric keypad

With these keys you can input the information or your selections on the radio. In tx mode, push the number keys to send a corresponding DTMF code.



### • \*πO Key

A short momentary press of the key enables the reverse function.

If you press this button for more than 2 seconds you will lock/unlock the keypad.

### • # Z Key

Standby mode, press the key to view battery voltage information. To enable the scanner, press and hold the # Z key for about two seconds.

When listening to broadcast FM a momentary press will start the scanning. Scanning in broadcast FM will stop as soon as an active station is found, regardless of scanner resume method.

## 5. BASIC OPERATIONS

### 5.1 Power on the radio

#### • Turning the unit on

To turn the unit on, simply rotate the **volume/power** knob clockwise until you hear a "click". If your radio powers on correctly there should be an audible double beep after about one second and the display will show a message or flash the LCD depending on settings for about one second. Then it will display a frequency or channel. If the Voice prompt is enabled, the voice will announce "frequency mode" or "channel mode".

#### • Turning the unit off

Turn the **volume/power** knob counter-clock wise all the way until you hear a "click". The unit is now off.



### 5.2 Adjusting the volume

To turn up the volume, turn the volume/power knob clock-wise. To turn the volume down, turn the **volume/power** knob counter-clock-wise. Be careful not to turn it too far, as you may inadvertently turn your radio off.

### 5.3 Channel selection

There are two modes of operation: Frequency (VFO) mode, and Channel or Memory (MR) mode.

For everyday use, Channel (MR) mode is going to be a whole lot more practical than Frequency (VFO) mode. However, Frequency (VFO) mode is very handy for experimentation out in the field. Frequency (VFO) mode is also used for programming channels into memory.

In Channel (MR) mode you can navigate up and down the channel by using the /  keys or the encoder. Ultimately which mode you end up using will depend entirely on your use case.

## 5.4 Making a call

**NOTE:** Press the  key to switch the main channel to the other channel if there are 2 channels shown on the display. In standby mode, press and hold the  key to switch between frequency (VFO) mode and channel (MR) mode.

- Channel mode call: After selecting a channel, hold down the [PTT] key to initiate a call to the current channel. Speak into the microphone with normal tone. Initiate a call, the red LED is on.
- Frequency mode call: The off state, hold press  key to open the radio, switching to the frequency mode, the frequency range allowed entering, press the [PTT] key, a call to the current channel. Speak into the microphone with normal tone. Initiate a call, the red LED is on.
- Receive a call: When you release the [PTT] key, you can answer it without any action.  
When receiving a call, the green LED is on.

**NOTE:** To ensure the best reception volume, keep the distance between the microphone and the mouth at the time of transmission from 2.5 cm to 5 cm.



## 5.5 Frequency (VFO) mode

In Frequency (VFO) mode you can navigate up and down the band by using the  keys. Each press will increment or decrement your frequency according to the frequency step you've set your transceiver to.

You can also input frequencies directly on your numeric keypad with kilohertz accuracy. The following example assumes the use of a 12.5 kHz frequency step.

**Example. Entering the frequency 432.56250 MHz on display A**

a. In standby mode, press and hold the  key to switch to the frequency (VFO) mode.

b. Press  until the  icon appears next to the upper display. .

c. Enter [4][3][2][5][6][2][5] [0] on the numeric keypad.

©In VFO mode, VFO will be displayed on the right. Any transmission is prohibited, and reception and scanning are allowed. Among them, the scanning frequency can be accurately set.

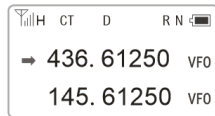

## WARNING!

Just because you can program in a channel does not mean you're automatically authorized to use that frequency. Transmitting on frequencies you're not authorized to operate on is illegal, and in most jurisdictions a serious offence. However, it is legal in most jurisdictions to listen. Contact your local regulatory body for further information on what laws, rules and regulations apply to your area.

## 5.6 Channel (MR) mode

The use of Channel (MR) mode is dependent on actually having programmed in some channels to use.

Once you have channels programmed and ready, you can use the  keys or the encoder to navigate between channels.

©In MR mode, the channel number will be displayed on the right. Among them, GMRS communication (CH1-CH30) allows transmission and reception. Channels other than CH01-CH30 can only be scanned and received, and transmission is prohibited.

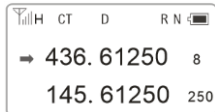

## 6. ADVANCED FEATURES

### 6.1 Frequency scanning

This function can scan the frequency.

- In frequency mode, press **# Z** key for more than 2 seconds. The radio will start scanning the frequency according to the set frequency step.
- You can change the scanning direction with the  keys.
- Press **# Z** key to stop the scanning.

**Note: for Scan mode, see Menu No.19.**

## 6.2 Channel scanning



Use scan to search the channels for transmissions from unknown parties, to find someone in your group who has accidentally changed channels or to quickly find unused channels for your own use.

- a. In channels mode, press **# Z** key for more than 2 seconds. The radio will start scanning according to the channel you set.
- b. You can change the scanning direction with the  keys.
- c. Press **# Z** key to stop scanning.

**Note: for Scan mode, see Menu No.19.**

## 6.3 CTCSS scanning



The function allows scanning the frequencies with CTCSS tone enabled.

- a. In standby mode, press  **[3][0]**, "SEEK 67.0" will appear on the display.
- b. Press  and the scan of CTCSS tones will start.

**NOTES: The function cannot be activated when the radio is set in Channel mode. The Scan will start only when the receiving band will detect a signal.**

## 6.4 DCS scanning

This function allows scanning the frequencies with DCS code enabled.

- a. In standby mode, press  **[3][1]**; the display will show "SEEK D023N".
- b. Press  and the scan of DCS codes will start.

**NOTES: The function cannot be activated when the radio is set in Channel mode. The Scan will start only when the receiving band will detect a signal.**

## 6.5 Cursor Conversion (A/B)

Directly press  key to move the cursor up and down. Then, you can modify or confirm the parameters indicated by the cursor.

Important1: GM-15Pro has a dual-frequency display function. In frequency mode, you will see on the display two different

receiving and transmitting frequencies; while in channel mode the two different channels will be displayed.



Important2: In frequency or channel mode, press the /  key to shift between the main channel A and the sub-channel B  
➔ on the display indicates on which channel (main channel A or sub channel B) you are operating.

## 6.7 Keypad lock



This function locks the keypad to prevent accidental pressure of the controls.

To unlock the keypad, press [**\*PTT**] for more than 2 seconds.

## 6.8 FM Radio (FM)

The frequency range to listen to the radio is 65-108MHz. When listening to broadcast FM, press /  key switches between 65-75 MHz and 76-108 MHz band.

A. In frequency or channel mode, Press [**FM/SOS**] to turn on the radio.

B. Select the desired radio frequency with the /  keys or input the frequency. Or

- Press **# Z** to automatically search a radio station.

C. Press [**FM/SOS**] to exit FM radio.

**Note: while you are listening to the radio, the frequency or channel of A / B receiving signal will automatically switch to the frequency or channel mode for normal transmitting and receiving.**

**When the signal disappears the radio will automatically switch again to FM radio mode.**

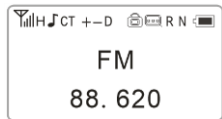

## 6.9 TX 1000Hz, 1450Hz, 1750Hz, 2100Hz repeaters tone

Press [**PTT**] + [**LAMP/Monitor**] to send 1750Hz repeaters tone. This function is useful for communications through repeaters.

If you have the keypad lock enabled on your radio, you can still send a 1750Hz tone the regular way without having to unlock your radio.

## 6.10 Manual Programming (Channels Memory)

Memory channels are an easy way to store commonly used frequencies so that they can easily be retrieved at a later date.

The POFUNG/Baofeng GM-15Pro features 220 memory channels that each can hold: Receive frequencies, group signaling

information, bandwidth, ANI/ PTT-ID settings and a six character alphanumeric identifier or channel name <sup>1</sup>.

## Frequency Mode vs. Channel Mode

**In standby mode, press and hold the  $\overline{=}$  key to switch between frequency (VFO) mode and channel (MR) mode.**

These two modes have different functions and are often confused.

**Frequency Mode (VFO)** : Used for a temporary frequency assignment, such as a test frequency or quick field programming if permitted.

**Channel Mode (MR)** : Used for selecting preprogrammed channels.

### Ex 1. Programming a Scan Channel with CTCSS Tone

EXAMPLE New memory in Channel 31:

RX = 432.55000 MHz

TX CTCSS tone 123.0

- A. Press the  $\overline{=}$  button to switch between menus.
- B. Press and hold the  $\overline{=}$  key to set the radio to VFO mode, and the VFO icon is displayed on the right.
- C.  $\overline{=}$  [2][8]  $\overline{=}$  [3] [1]  $\overline{=}$   $\overline{=}$  Deletes Prior Data in channel (Ex. 31)
- D.  $\overline{=}$  [1][0]  $\overline{=}$  123.0  $\overline{=}$   $\overline{=}$  Selects desired RX encode tone
- E. Enter RX frequency (Ex. **43255000**)
- F.  $\overline{=}$  [2][7]  $\overline{=}$  [3][1]  $\overline{=}$  Enter the desired channel (Ex 31)  
-->> $\overline{=}$  RX has been added
- G. Press and hold the  $\overline{=}$  key to return to the MR mode and the channel number will reappear.

### Ex 2. Channel memory for scanning frequency

EXAMPLE New memory in Channel 31:

Scans frequency ranger 430-435MHz

RX = 432.55000 MHz

RX DCS D023N



A. Press the [↔] button to switch between menus.

B. Press and hold the [≡] key to set the radio to VFO mode, and the VFO icon is displayed on the right.

C. [≡] [1][8] [≡]

Enter the scan range menu

D. Enter [4][3][0][4][3][5] [≡] [↔]

Enter the scan frequency range

E. Press and hold the # Z key to start frequency scan, 432.55000 frequency points start to scan.

Frequency required for scanning

There is activity, stay here temporarily, press [PTT] key to stop scanning, confirm the required frequency.

Stop scanning, the required storage frequency

F. [≡] [9] [≡] [1] [≡] [↔]

Select desired RX encode sub tone (Ex D023N DCS)

G. [≡] [2][8] [≡] [3] [1] [≡] [↔]

Deletes Prior Data in channel (Ex. 31)

H. [≡] [2][7] [≡] [3][1] [≡]

Enter the desired channel (Ex 31)

-->> [↔]

Channel has been added

I. Press and hold the [≡] key to return to the MR mode and the channel number will reappear.

## 6.11 Built-in LED Flashlight

Press the flashlight button to turn and keep the light on. Press the flashlight button again, the light is off.

Note: Turn off the flashlight when not in use to conserve battery power.

## 6.12 NOAA weather Receiver /Scan

Your radio can tune in to broadcasts by the United States National Oceanic and Atmospheric Administration (NOAA) Weather Radio and Environment Canada Weather Radio.

Your radio has a NOAA weather receiver function, to enable the user to receive weather reports from designated NOAA stations.

Your radio also has a NOAA weather scan function, to enable the user to scan all 11 channels of the NOAA weather receiver. To turn the NOAA weather receiver on, press and hold the [↔] key for 5 seconds while in GMRS mode. While in NOAA weather band mode press the UP/DOWN buttons to select one of the 11 NOAA weather band channels.

Press and hold the # Z key will go to NOAA weather band mode and start scanning all 11 channels and stop on any active channel. When the channel becomes inactive for 10 seconds the radio will resume scanning.

To stop the NOAA weather scans and set the channel manually on the NOAA weather band, press the # **Z** key during NOAA weather scan. The radio will stop scanning and the display will show the current WX Band channel setting.

To turn the NOAA weather receiver off, press the  key.

**Note:** NOAA weather radio stations are assigned to cover specific areas and service may be limited. Please check with your local weather office for frequency and details or visit [www.weather.gov/nwr](http://www.weather.gov/nwr) in the US to view the appropriate transmitter for your area. When you listen to a weather channel, you cannot use your radio in scan mode or for GMRS communications.







## 7. WORKING THE MENU SYSTEM

For a complete reference on available menu items and parameters, see **Appendix C, Shortcut Menu operations**.

**Note: in channel mode, the setting of these features is not possible: CTCSS/ DCS tones, wide/narrow bandwidth, PTT-ID, Busy channel lock out, channel name edit.**

### 7.1 Basic use

Using the menu with arrow keys

- A. Press the  key to enter the menu.
- B. Use the  keys to navigate between menu items.
- C. Once you find the desired menu item, press  again to select that menu item.
- D. Use the  keys to select the desired parameter.
- E. When you've selected the parameter you want to set for a given menu item;
  - a). To confirm your selection, press  and it will save your setting and bring you back to the main menu.
  - b). To cancel your changes, press  and it will reset that menu item and bring you out of the menu entirely.
- F. To exit out of the menu at any time, press the  key.

### 7.2 Using short-cuts

As you may have noticed if you looked at **Appendix C, Shortcut Menu operations**, every menu item has a numerical value associated with it. These numbers can be used for direct access of any given menu item.

The parameters also have a number associated with them; see **Appendix C, Shortcut Menu operations** for details.

Using the menu with short-cuts

- A. Press the **[≡]** key to enter the menu.
- B. Use the numerical keypad to enter the number of the menu item.
- C. To enter the menu item, press the **[≡]** key.
- D. For entering the desired parameter you have two options:
  - a). Use the arrow keys as we did in the previous section; or
  - b). Use the numerical keypad to enter the numerical short-cut code.
- E. And just as in the previous section;
  - a). To confirm your selection, press **[≡]** and it will save your setting and bring you back to the main menu.
  - b). To cancel your changes, press **[↩]** and it will reset that menu item and bring you out of the menu entirely.
- F. To exit out of the menu at any time, press the **[↩]** key.
- G. All further examples and procedures in this manual will use the numerical menu short-cuts.

## 7.3 Functions and operations

### (1) Squelch level (Squelch) - MENU No.0

Thanks to this function you can adjust the squelch in 10 different levels:

- **Level 0:** opened squelch. With this setting, GM-15Pro will detect all signals, also the weakest ones, but will also receive the background noise or undesired signals.
- **Levels 1- 9:** level 1 (lowest squelch level), level 9 (highest squelch level).

If the squelch is set to the highest level, the radio will receive the strongest signals only.

### (2) Step frequency (Step) - MENU No.1

This function lets you select the desired frequency step.

The selectable steps are the following: 2.5/5.0/6.25/10.0/12.5/20.0/25.0/50.0 KHz

**Note: in channel mode, this function cannot be modified.**

### (3) Power save (Power Save) - MENU No.2

The power save feature enables a reduction in the consumption of the battery when the radio is in standby. You have 5 selections available: Off/ Mode 1/ Mode 2/ Mode 3/ Mode 4. For example: Mode 1= 1s' working and 1s' battery saving. Mode 2= 1s' working and 2s' battery is saving.

**NOTE: The higher the number the longer the battery lasts. The higher number increases the RX sleep cycle, but you may miss the first few syllables before the RX opens**

#### **(4) VOX Function (Vox Level ) - MENU No.3**

This function allows hands-free conversations: just speak in the direction of the microphone and the communication will be automatically activated.

You can choose amongst 11 levels: Off, 1-9. 1 is the highest level, 9 is the lowest one. If this option is set to Off, the VOX function is turned off

**Note: the higher is the level, the higher is the microphone sensitivity. The VOX function cannot be modified in SCAN and FM radio mode.**

#### **(6) Backlight (Backlight) - MENU No. 5**

With this function you can adjust the auto off time of the display backlight (Bright, 1-10Sec).

When the option is Bright, the backlight is always on, which will affect the battery standby time.

**Note: we suggest you setting 4-5s levels.**

#### **(7) Dual Watch Operation (D.Wait) - MENU No. 6**

When this function is activated, you can receive the frequency of channel A and channel B at the same time.

If a signal is detected, the ▼/▲ pointer will blink on the corresponding channel or frequency.

**Note: In Dual Watch operation mode, you can change the parameter of AB channel or frequency freely.**

#### **(8) Keypad beep (Beep) - MENU No. 7**

When this function is enabled, every time a button is pressed, you will hear a beep tone.

#### **(9) Time-Out-Timer (TOT) - MENU No.8**

The TOT function is used to prevent a too long transmission and limits the tx time: TOT temporarily stops the transmission if the radio has been used beyond the max pre-set time (for example 15s, 30s, 45s, etc).

**Note: If this option is set to OFF, press and hold the PTT key to keep transmission.**

## **(10) Receiving DCS (Rx DCS) - MENU No.9**

DCS codes are similar to access codes and can be added to channels, so as to create a sort of personal channel. They enable the radio to communicate with the users that are tuned on the same channel and have set the same DCS code.

You can choose amongst:

- **Off:** Off
- D023N-D754N (Normal DCS), D023I-D754I (Inverse DCS)

**Note: In GM-15Pro there are 208 groups of normal and inverse DCS codes. This function cannot be amended in channel mode.**

## **(11) Receiving CTCSS (Rx CTCSS) - MENU No.10**

As DCS codes, the CTCSS codes can be added to the channels for creating new private channels.

**Note: there are 50 groups of CTCSS tones. In channel mode the CTCSS tones cannot be changed.**

## **(12) Transmitting DCS (Tx DCS) - MENU No.11**

In this Menu you activate DCS codes in tx mode. You can choose between normal R-DCS (D023N-D754N) and inverted R-DCS (D023I-D754I)

**Note: the groups of DCS codes are 208. DCS codes cannot be changed in channel mode.**

## **(13) Transmitting CTCSS (Tx CTCSS) - MENU No.12**

In this Menu you can set a CTCSS tone in tx mode.

You can choose: Off or CTCSS (67.0 to 254.1 Hz)

**Note: there are 50 groups of CTCSS tones. In channel mode the CTCSS tones cannot be changed.**

## **(14) Voice prompts function (Voice) - MENU No. 13**

With this function, you activate a voice that informs you about any operation/ selection you are doing.

### **(15) ANI-ID (ANI-ID) - MENU No.14**

With this function you can set your ID-code. It can be programmed by the proper programming software. You can edit up to 5 digits.

### **(16) DTMFST (DTMFST) - MENU No.15**

Determines when DTMF Side Tones can be heard from the transceiver speaker. You can choose amongst four options:

- **Off:** No DTMF Side Tones are heard
- **DT-ST :** Side Tones are heard only from manually keyed DTMF codes
- **ANI-ST:** Side Tones are heard only from automatically keyed DTMF codes
- **DT+ANI:** All DTMF Side Tones are heard

### **(17) Signal Code (S-CODE) - MENU No.16**

Selects 1 of 15 DTMF codes. The DTMF codes are programmed with software and are up to 5 digits each.

### **(18) Scan Add (Scan Add) - MENU No.17**

In channel mode, to scan the current channel, the channel must be added to the scan group.

- **On:** Turn on the scan function of the current channel.
- **Off:** Do not scan the current channel.

### **(19) Scan ranger (Scan Ran) - MENU No.18**

In frequency mode, the frequency sweep range can be precisely set. Input the start value and end value of the sweep frequency through the keyboard.

EX: Enter 144146, in frequency mode, scan in the range of 144.000-146.000MHZ. Enter 430450, in frequency mode, scan in the range of 430.000-450.000MHZ.

Note: channel mode, the set frequency range is invalid and cannot be saved.

## **(20) SCAN Resume Mode (Scan Mode) - MENU No.19**

Thanks to this function, GM-15Pro can SCAN in frequency or channel mode. You can choose amongst three options:

- **Time-operated SCAN**

Whenever a signal is detected, the radio will suspend the SCAN for 5 seconds, and then will continue to SCAN even if the signal is still present.

- **Carrier-operated SCAN**

Whenever a signal is detected, the radio will stop scanning. It will resume to SCAN once the signal will disappear.

- **Search -Search SCAN**

The radio will stop scanning once a signal is detected.

## **(21) PTT-ID (PTT-ID) - MENU No.20**

With this function you can decide when sending the ANI-ID code in tx mode.

You can choose amongst 4 possibilities.

- **Off:** press PTT to turn it off
- **BOT:** the code is sent when you press the PTT
- **EOT:** the code is sent when the PTT is released
- **BOTH:** the code is sent when you press and release the PTT

**Note: select 'OFF' when using in case of affecting the radio.**

## **(22) Channel A Display Mode (MDF-A) - MENU No.21**

This function is used to set the display mode of channel A.

Display modes:

- **Frequency:** Frequency + channel No.
- **Name:** Channel name

**Note: Channel name mode must be set by the programming software. Up to three numbers or characters can be edited.**

## **(23) Channel B Display Mode (MDF-B) - MENU No.22**

This function is used to set the display mode of channel B.

Display modes:

- **Frequency:** Frequency + channel No.
- **Name:** Channel name

**Note: Channel name mode must be set by the programming software. Up to three numbers or characters can be edited.**

## **(24) Busy Channel Lock (Busy Lock) - MENU No. 23**

When this function is on, it may prevent other radios' interference. If the selected channel is being used by other radios, when you press key PTT, your radio cannot transmit.

Release the PTT and transmit as soon as the frequency is no longer busy.

## **(25) Auto Keypad Lock (AUTO LK) - MENU No.24**

When this feature is activated, the keypad will be automatically locked after 15s; this prevents accidental pressure of any keys.

The keypad lock can be manually activated/deactivated through the keypad: keep pressed [\*PTT].

## **(26) Frequency offset direction (Direction) - MENU No.25**

Using this function, you can set the direction of the frequency offset in rx and tx.

You have the following options:

- **Plus: Positive offset;**
- **Minus: Negative offset;**
- **None: None offset.**

**Note: you should set different frequency deviation according to the repeaters selected. This function is not enabled in channel mode.**

## **(27) Frequency offset (Offset) - MENU No. 26**

In this MENU you can set the deviation between tx and rx. The frequency offset of this radio is 00.000-99.998MHz.



## **(28) Channel store - (Memory) - MENU No. 27**

When the radio is in frequency working mode or standby mode, input the desired frequency or parameters directly.

**NOTES:** If you want to set CTCSS tones, DCS codes or the frequency offset, you have to do it before storing the channel. The channels already stored are displayed as CH-XXX ("CH" and -channel number), and other channels only display channel numbers.

## **(29) Channel Delete (Delete) - MENU No.28**

In this menu you can delete a channel of the radio.

## **(30) Alarm Mode (Alarm Mode) - MENU No.29**

This function can set the tone alarm/code alarm/site alarm of the radio.

**Keep pressed the [FM/SOS] key for 3 seconds to start the alarm tone.**

The following three options can be selected:

- **Site:** the speaker emits an alarm tone but the radio doesn't transmit;
- **Tone:** the speaker emits an alarm tone and the radio transmits it;
- **Code:** the speaker emits an alarm tone and the radio transmits it followed by ANI-ID code.

## **(31) Scan of frequencies with CTCSS (SEEK CTC) - Menu No. 30**

The function allows scanning the frequencies with CTCSS tone enabled.

**NOTES:** The function cannot be activated when the radio is set in Channel mode. The Scan will start only when the receiving band will detect a signal.

## **(32) Scan of frequencies with DCS (SEEK DCS) - Menu No. 31**

This function allows scanning the frequencies with DCS code enabled.

**NOTES:** The function cannot be activated when the radio is set in Channel mode. The Scan will start only when the receiving band will detect a signal.

### **(33) Squelch tail elimination (TAIL) - Menu No. 32**

This function is used to eliminate squelch tail noise between POFUNG/Baofeng handhelds that are communicating directly (no repeater). Reception of a 55 Hz or 134.4 Hz tone burst mutes the audio long enough to prevent hearing any squelch tail noise.

### **(34) Squelch tail elimination of repeater (RP-STE) - Menu No. 33**

This function is used when the radio operates through a repeater; when the PTT is released, the repeater will emit the end transmission tone to confirm it is working.

Available settings:

Off, 1,2,3,4,5,...10 to set the delay time.

**Note: Please disable this function in normal use, lest affect your normal conversation.**

### **(35) Delay the squelch tail of repeater (RPT-RL) - Menu No.34**

With this function you have the confirmation that the repeater has transferred the signal. You can choose amongst: Off 1,2,3,4,5,...10 to set the delay time.

### **(36) Roger beep (ROGER) - Menu No. 35**

When the PTT is released, the radio will beep to confirm to other users that you have finished your transmission and that they can start talking.

### **(37) 1750Hz Repeater Tone (R-TONE) - Menu No.36**

With this function you can select 1000Hz, 1450Hz, 1750Hz, 2100Hz repeater tone. To send out a repeater tone; You hold down the [PTT] + [SK2] key.

If you have the keypad lock enabled on your radio, you can still send a 1750Hz tone the regular way without having to unlock your radio.

### **(38) Power on image (OPNSET) - Menu No.37**

With this function you can set the display mode when the radio is turned on. Available options:

- **Logo:** Display the preset startup picture.
- **Msg:** Welcome message.
- **Voltage:** The power voltage is momentarily displayed.

### **(39) Language selection (Language) - Menu No. 38**

With this function, you can select the language of the LCD display and operation prompt.

### **(40) Frequency hopping system (Hopping RX) - MENU No. 39**

With this function, you can activate the frequency hopping system, improve the anti-interference ability of the radio, and reduce the risk of being monitored.

### **(41) Reset (Reset) - Menu No.40**

With this function you can reset the transceiver to the factory-programmed settings and parameters. After that, you can set the desired functions.

There are two types of reset:

- **VFO:** Menu Reset
- **ALL:** Menu and channel Reset

### **(42) Dual Band single display (SYNC) - Menu No.41**

The radio is dual-band, dual-display, and the screen can display A/B frequency band at the same time. It can also be set to dual-band single-screen display. When single frequency point is displayed, the channel nickname, frequency and channel number will be displayed at the same time.

- **On:** Turn on the SYNC function and display the alias, frequency and channel number of the current channel.
- **Off:** Turn off the SYNC function, which is a dual-segment dual display mode. The main frequency and sub frequency will be displayed.

## 8. ON-LINE SERVICE AND SUPPORT

The POFUNG/ Baofeng website provides additional information about obtaining service or support for the POFUNG/ Baofeng line of two-way radios and accessories.

Warning Notes every effort has been made to ensure that the information in this document is complete, accurate, and up to-date. POFUNG Radio assumes no responsibility for the results of errors beyond its control. The manufacturer of this equipment also cannot guarantee that changes in the equipment made by non-authorized users will not affect the information in it.

## Appendix A. – Trouble shooting guide

Phenomena	Analysis	Solution
You cannot turn on the radio.	The battery may be installed improperly.	Remove and reattach the battery.
	The battery power may run out.	Recharge or replace the battery.
	The battery may suffer from poor contact caused by dirty or damaged battery contacts.	Clean the battery contacts or replace the battery.
During receiving, the voice is weak or intermittent.	The battery voltage maybe low.	Recharge or replace the battery.
	The volume level may be low.	Increase the volume.
	The antenna maybe loose or maybe installed incorrectly.	Turnoff the radio, and then remove and reattach the antenna.
	The speaker maybe blocked.	Clean the surface of the speaker.
You cannot communicate with other group members.	The frequency or signaling type maybe inconsistent with that of other members.	Verify that your TX/RX frequency and signaling type are correct.
	You may be too far away from other members.	Move towards other members.
You hear unknown voices or noise.	You may be interrupted by radios using the same frequency.	Change the frequency, or adjust the squelch level.
	The radio in analog mode maybe set with no signaling.	Request your dealer to set signaling for the current channel to avoid interference
You are unable to hear anyone because of too much noise and hiss.	You may be too far away from other members.	Move towards other members.
	You may be in an unfavorable position. For example, your communication may be blocked by high buildings or blocked in an underground area.	Move to an open and flat area, restart the radio, and try again.
	It may be the result of external disturbance (such as electromagnetic interference).	Stay away from equipment that may cause interference.
The radio keeps transmitting.	VOX may be turned on or the headset is not installed in place	Turn off the VOX function. Check that the headphones are in place.

**NOTE: If the above solutions cannot fix your problems, or you may have some other queries, please contact your dealer for more technical support.**

## Appendix B. - Technical Specifications

### General

Frequency Range	GMRS(RX & TX) 136-174 & 400-512MHz(Scanning RX)
Memory Channel	30 GMRS+11 NoAA weather Channels+220 Scanner
Operation Voltage	DC 7.4 V $\pm$ 10%
Battery Capacity	1500mAh (Li-Ion)
Frequency Stability	$\pm$ 2.5ppm
Operating Temperature	-20°C to +50°C
Mode of Operation	Simplex
Antenna Impedance	50ohm

### Transmitter Part

RF Output Power	$\leq$ 5W(GMRS)
FM Modulation	11K0F3E@12.5KHz
Adjacent Channel Power	60dB @ 12.5KHz
Transmission current	$\leq$ 1500mA





### Receiver Part

Receive Sensitivity	0.25 $\mu$ V (12dB SINAD)
Adjacent Channel Selectivity	$\geq$ 55dB@12.5KHz
Inter Modulation and Rejection	$\geq$ 55dB@12.5KHz
Conducted Spurious Emission	$\leq$ -57dB@12.5KHz
Rated Audio Power Output	1W @16 ohms
Receive current	$\leq$ 380mA
Rated Audio Distortion	$\leq$ 5%



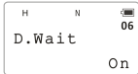

**NOTE: All specifications may be modified without prior notice or liability. Thank you.**



## Appendix C. - Shortcut Menu operations

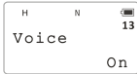
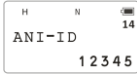

MENU No.	Name (Full Name)	Enter item	LCD display	Selectable
0	Squelch - Squelch Level	MENU+0		0-9 Levels 0:Lowest 9:Highest
1	Step –Step Frequency	MENU+1		2.5K/5.0K/6.25K/10.0K 12.5K/20.0K/25.0K/50.0K
2	Power Save - Battery Saving	MENU+2		OFF: 1, 2, 3, 4
3	Vox Level - VOX	MENU+3		Off, 1-9 Off: off 1:Highest Sensitivity 9:Lowest Sensitivity
4	Bandwidth /Narrow Bandwidth	MENU+4		Wide:25.0K Narrow:12.5K
5	Backlight –Auto Backlight	MENU+5		Bright/1,2,3...8, 9,10Sec <b>*Time-out for the LCD backlight. (seconds)</b>



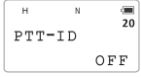
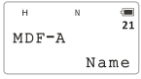
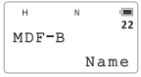

6	D.Wait – Dual Watch Operation	MENU+6		Off On <b>*Monitor [A] and [B] at the same time. The display with the most recent activity ([A] or [B]) becomes the selected display.</b>
7	Beep- Keypad Beep	MENU+7		Off On <b>*Allows audible confirmation of a key press.</b>
8	TOT - Time-Out-Timer	MENU+8		15,30...600S <b>*This feature provides a safety switch that limits transmission time to a programmed value. This will promote battery conservation by not allowing you to make excessively long transmissions, and in the event of a stuck PTT switch it can prevent interference to other users as well as battery depletion</b>
9	Rx DCS - Receiver DCS	MENU+9		Off D023N...D754N; D023I ...D754I <b>*Mutes the speaker of the transceiver in the absence of a specific low-level digital signal. If the station you are listening to does not transmit this specific signal, you will not hear anything.</b>
10	Rx CTCSS - Receiver CTCSS	MENU+10		Off 67.0HZ...254.1HZ <b>*Mutes the speaker of the transceiver in the absence of a specific and continuous sub-audible signal. If the station you are Listening to does not transmit this specific and continuous signal, you will not hear anything.</b>



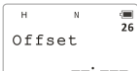
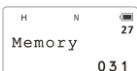
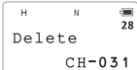



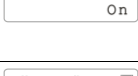
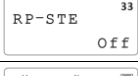
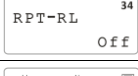

11	Tx DCS -Transmitter DCS	MENU+11		Off D023N...D754N; D023I ...D754I <b>*Transmits a specific low-level digital signal to unlock the squelch of a distant receiver (usually a repeater).</b>
12	Tx CTCSS - Transmitter CTCSS	MENU+12		Off 67.0HZ...254.1HZ <b>*Transmits a specific and continuous sub audible signal to unlock the squelch of a distant receiver (usually a repeater).</b>
13	Voice - Voice Reminding	MENU+13		Off On <b>*Allows audible voice confirmation of a key press.</b>
14	ANI-ID	MENU-14		<b>Displays the ANI code that has been set by software. This menu cannot be used to change it.</b>
15	DTMFST - DTMFST	MENU+15		OFF: No DTMF Side Tones are heard DT-ST : Side Tones are heard only from manually keyed DTMF codes ANI-ST: Side Tones are heard only from automatically keyed DTMF codes DT+ANI : All DTMF Side Tones are heard
16	S-CODE - Signal Code	MENU+16		1,...,15 <b>* Signal code (only could be set by PC software)</b>

17	Scan Add-Scan channel add	MENU+17		<p>ON: the current channel is added to the scan, the scan current channel</p> <p>OFF: Do not scan the current channel.</p>
18	Scan Ran- Scan Frequency Range	MENU+18		<p>136-174 &amp; 400-520MHz</p> <p>*Ex. 144 148 input and scan range is 144.0000-148.0000</p> <p>* Scanning frequency range, valid in VFO mode. The channel mode, invalid input, cannot be saved</p>
19	Scan Mode - Scanner Resume Method	MENU+19		<p>Time - scanning will resume after a fixed time has passed</p> <p>Carrier -scanning will resume after the signal disappears</p> <p>Search -scanning will not resume</p>
20	PTT-ID - PTT-ID	MENU+20		<p>Off: No ID is sent</p> <p>BOT: The selected S-CODE is sent at the beginning</p> <p>EOT: The selected S-CODE is sent at the ending</p> <p>BOTH : The selected S-CODE is sent at the beginning and ending</p>
21	MDF-A - Channel A Display Mode	MENU+21		<p>Frequency: Displays programmed Frequency</p> <p>Name: Displays the channel name</p> <p><b>*Note: Names must be entered using software.</b></p>
22	MDF-B - Channel B Display Mode	MENU+22		<p>Frequency: Displays programmed Frequency</p> <p>Name: Displays the channel name</p> <p><b>*Note: Names must be entered using software.</b></p>

23	Busy Lock – Busy Channel Lock-out	MENU+23		Off On <b>*Disables the [PTT] button on a channel that is already in use. The transceiver will sound a beep tone and will not transmit if the [PTT] button is pressed when a channel is already in use.</b>
24	AUTO LK –Automatic Keypad Lock	MENU+24		Off On <b>*When ON, the keypad will be locked if not used in 8 seconds. Pressing the [*PTT] key for 2 seconds will unlock the keypad.</b>
25	Direction – Frequency Offset Direction	MENU+25		None: TX = RX (simplex) Plus: TX will be shifted higher in frequency than RX Minus : TX will be shifted lower in frequency than RX
26	Offset -Frequency shift amount	MENU+26		00.000...99.998 <b>*Specifies the difference between the TX and RX frequencies</b>
27	Memory - Store a Memory Channel	MENU+27		000...250 <b>*This menu is used to either create new or modify existing channels (0 through 250) so that they can be accessed from MR/Channel Mode</b>
28	Delete - Delete a memory channel	MENU+28		000...250 <b>*This menu is used to delete the programmed information from the specified channel (0 through 250) so that it can either be programmed again or be left empty.</b>

29	Alarm Mode - Alarm Mode	MENU+29		Site: Sounds alarm through your radio speaker only Tone: Sending alarm tone Code: Sending alarm code
30	SEEK CTC -Scan of frequencies with CTCSS	MENU+30		67.0HZ,...,254.1HZ <b>*Automatic stop after receiving the CTCSS signal</b>
31	SEEK DCS -Scan of frequencies with DCS	MENU+31		D023N,...,D754I <b>*Automatic stop after receiving the DCS signal</b>
32	TAIL - Squelch Tail Elimination	MENU+32		On Off <b>*This function is used eliminate squelch tail noise between POFUNG/Baofeng handhelds that are communicating directly (no repeater). Reception of a 55 Hz or 134.4 Hz tone burst mutes the audio long enough to prevent hearing any squelch tail noise.</b>
33	RP-STE-Squelch Tail Elimination	MENU+33		Off/ 1,2,3...10 <b>*This function is used eliminate squelch tail noise when communicating through a repeater.</b>
34	RPT-RL - Delay the squelch tail of repeater	MENU+34		Off/ 1,2,3...10 <b>*Delay the Tail Tone of Repeater (X100 milliseconds)</b>
35	ROGER - Roger Beep	MENU+35		Off On <b>*Sends an end-of-transmission tone to indicate to other stations that the transmission has ended.</b>

36	R-TONE–Repeater Tone	MENU+36	 <p>H N 36 R-TONE 1750Hz</p>	1000Hz/1450Hz/1750Hz/2100Hz <b>*To send out a repeater tone; You hold down the [PTT] + [LAMP/MONI] key.</b>
37	OPNSET -Power On Message	MENU+37	 <p>H N 37 OPNSET Msg</p>	Logo: Performs an LCD screen test at power-on Msg : Displays a 2-line power on message Voltage: <b>*Controls the behavior of the display when the transceiver is turned on.</b>
38	Language- Language selection	MENU+38	 <p>H N 38 Language English</p>	English
39	Hopping RX- Frequency hopping system	MENU+39	 <p>H N 39 Hopping RX Off</p>	Off On
40	RESET – Restore defaults	MENU+40	 <p>H N 40 Reset ALL</p>	VFO: Menu initialization ALL: Menu and channel initialization <b>*Resets the radio to factory defaults, with some exceptions.</b>
41	SYNC- Dual Band single display	MENU+41	 <p>H N 41 SYNC On</p>	ON: Enable single band 2 line display, a display alias frequency; OFF: Normal display status.

## Appendix D. - GMRS Frequency Chart (MHz)

CH.No	CH.Freq.	Type of Radio	Power Output	CH.No	CH.Freq.	Type of Radio	Power Output
1	462.5625	GMRS	High	16	462.5750	GMRS	High
2	462.5875	GMRS	High	17	462.6000	GMRS	High
3	462.6125	GMRS	High	18	462.6250	GMRS	High
4	462.6375	GMRS	High	19	462.6500	GMRS	High
5	462.6625	GMRS	High	20	462.6750	GMRS	High
6	462.6875	GMRS	High	21	462.7000	GMRS	High
7	462.7125	GMRS	High	22	462.7250	GMRS	High
8	467.5625	FRS	Low	23	467.5500/462.5500	RPT	High
9	467.5875	FRS	Low	24	467.5750/462.5750	RPT	High
10	467.6125	FRS	Low	25	467.6000/462.6000	RPT	High
11	467.6375	FRS	Low	26	467.6250/462.6250	RPT	High
12	467.6625	FRS	Low	27	467.6500/462.6500	RPT	High
13	467.6875	FRS	Low	28	467.6750/462.6750	RPT	High
14	467.7125	FRS	Low	29	467.7000/462.7000	RPT	High
15	462.5500	GMRS	High	30	467.7250/462.7250	RPT	High

\* Channels 8~14 are low-power FRS license free channels.

## Appendix E. - DCS Table

### DCS CODE LIST

Number	Code	Number	Code	Number	Code	Number	Code	Number	Code
1	D023N	2	D025N	3	D026N	4	D031N	5	D032N
6	D036N	7	D043N	8	D047N	9	D051N	10	D053N
11	D054N	12	D065N	13	D071N	14	D072N	15	D073N
16	D074N	17	D114N	18	D115N	19	D116N	20	D122N
21	D125N	22	D131N	23	D132N	24	D134N	25	D143N
26	D145N	27	D152N	28	D155N	29	D156N	30	D162N
31	D165N	32	D172N	33	D174N	34	D205N	35	D212N
36	D223N	37	D225N	38	D226N	39	D243N	40	D244N
41	D245N	42	D246N	43	D251N	44	D252N	45	D255N
46	D261N	47	D263N	48	D265N	49	D266N	50	D271N
51	D274N	52	D306N	53	D311N	54	D315N	55	D325N
56	D331N	57	D332N	58	D343N	59	D346N	60	D351N
61	D356N	62	D364N	63	D365N	64	D371N	65	D411N
66	D412N	67	D413N	68	D423N	69	D431N	70	D432N
71	D445N	72	D446N	73	D452N	74	D454N	75	D455N
76	D462N	77	D464N	78	D465N	79	D466N	80	D503N
81	D506N	82	D516N	83	D523N	84	D526N	85	D532N
86	D546N	87	D565N	88	D606N	89	D612N	90	D624N
91	D627N	92	D631N	93	D632N	94	D645N	95	D654N
96	D662N	97	D664N	98	D703N	99	D712N	100	D723N

101	D731N	102	D732N	103	D734N	104	D743N	105	D754N
106	D023I	107	D025I	108	D026I	109	D031I	110	D032I
111	D036I	112	D043I	113	D047I	114	D051I	115	D053I
116	D054I	117	D065I	118	D071I	119	D072I	120	D073I
121	D074I	122	D114I	123	D115I	124	D116I	125	D122I
126	D125I	127	D131I	128	D132I	129	D134I	130	D143I
131	D145I	132	D152I	133	D155I	134	D156I	135	D162I
136	D165I	137	D172I	138	D174I	139	D205I	140	D212I
141	D223I	142	D225I	143	D226I	144	D243I	145	D244I
146	D245I	147	D246I	148	D251I	149	D252I	150	D255I
151	D261I	152	D263I	153	D265I	154	D266I	155	D271I
156	D274I	157	D306I	158	D311I	159	D315I	160	D325I
161	D331I	162	D332I	163	D343I	164	D346I	165	D351I
166	D356I	167	D364I	168	D365I	169	D371I	170	D411I
171	D412I	172	D413I	173	D423I	174	D431I	175	D432I
176	D445I	177	D446I	178	D452I	179	D454I	180	D455I
181	D462I	182	D464I	183	D465I	184	D466I	185	D503I
186	D506I	187	D516I	188	D523I	189	D526I	190	D532I
191	D546I	192	D565I	193	D606I	194	D612I	195	D624I
196	D627I	197	D631I	198	D632I	199	D645I	200	D654I
201	D662I	202	D664I	203	D703I	204	D712I	205	D723I
206	D731I	207	D732I	208	D734I	209	D743I	210	D754I



## Appendix F. - CTCSS Table

CTCSS CHART (Hz)

Number	Frequency	Number	Frequency	Number	Frequency	Number	Frequency	Number	Frequency
1	67.0	2	69.3	3	71.9	4	74.4	5	77.0
6	79.7	7	82.5	8	85.4	9	88.5	10	91.5
11	94.8	12	97.4	13	100	14	103.5	15	107.2
16	110.9	17	114.8	18	118.8	19	123.0	20	127.3
21	131.8	22	136.5	23	141.3	24	146.2	25	151.4
26	156.7	27	159.8	28	162.2	29	165.5	30	167.9
31	171.3	32	173.8	33	177.3	34	179.9	35	183.5
36	186.2	37	189.9	38	192.8	39	196.6	40	199.5
41	203.5	42	206.5	43	210.7	44	218.1	45	225.7
46	229.1	47	233.6	48	241.8	49	250.3	50	254.1

## Appendix G.- NOAA Weather Radio Frequency List (US, CAN)

Channel No.	RX Freq.(MHz)	Chan.	RX Freq.(MHz)
WEATHER 01	162.5500	WEATHER 07	162.5250
WEATHER 02	162.4000	WEATHER 08	161.6500
WEATHER 03	162.4750	WEATHER 09	161.7750
WEATHER 04	162.4250	WEATHER10	161.7500
WEATHER 05	162.4500	WEATHER11	162.000
WEATHER 06	162.5000		

\* Channel 8, 9 are designated Canadian Marine Frequencies

## Disclaimer

The Company endeavors to achieve the accuracy and completeness of this manual, but no warranty of accuracy or reliability is given. All the specifications and designs are subject to change without notice due to continuous technological development. No part of this manual may be copied, modified, translated, or distributed in any manner without the prior written consent of the Company.

We do not guarantee, for any particular purpose, the accuracy, validity, timeliness, legitimacy or completeness of the third-party products and contents involved in this manual.

**Baofeng radio ltd.co &**

**PO FUNG ELECTRONIC (HK) INTERNATIOANL GROUP COMPANY**

Address: 3/F FULOK BLDG 131-133 WING LOK ST SHEUNG WAN, Hong Kong

E-mail: [sales@pofungshop.com](mailto:sales@pofungshop.com)

[Http://www.pofungshop.com](http://www.pofungshop.com)

Print version: GM-15Pro\_GMRS\_V1